



GigaVUE-TA200E Hardware Installation Guide

GigaVUE TA Series

Product Version: 6.6

Document Version: 1.1

Last Updated: Friday, October 11, 2024

(See Change Notes for document updates.)

Copyright 2024 Gigamon Inc. All rights reserved.

Information in this document is subject to change without notice. The software described in this document is furnished under a license agreement or nondisclosure agreement. No part of this publication may be reproduced, transcribed, translated into any language, stored in a retrieval system, or transmitted in any form or any means without the written permission of Gigamon Inc.

Trademark Attributions

Gigamon and the Gigamon logo are trademarks of Gigamon in the United States and/or other countries. Gigamon trademarks can be found at www.gigamon.com/legal-trademarks. All other trademarks are the trademarks of their respective owners.

Gigamon Inc.
3300 Olcott Street
Santa Clara, CA 95054
408.831.4000

Change Notes

When a document is updated, the document version number on the cover page will indicate a new version and will provide a link to this Change Notes table, which will describe the updates.

Product Version	Document Version	Date Updated	Change Notes
6.6	1.1	10/11/2024	This update includes bug fixes and minor cosmetic changes for improved usability and document consistency.
6.6	1.0	03/22/2024	The original release of this document with 6.6 GA.

Contents

GigaVUE-TA200E Hardware Installation Guide	1
Change Notes	3
Contents	4
GigaVUE TA Series Overview	6
GigaVUE TA Series Nodes	6
GigaVUE TA Series Features and Benefits	8
Standard GigaVUE HC Series Features	9
Introducing the GigaVUE-TA200E Chassis	10
GigaVUE-TA200E Ports and Description	11
Chassis Cooling	13
Power LEDs	14
System LED	14
Port Status LEDs	14
Global Fan LED	15
GigaVUE-TA200E Rules and Notes	15
AMI BIOS Images	15
Air Flow Direction	16
AC and DC-Powered GigaVUE TA Series-TA200E Models	16
Battery Caution	16
Breakout Modes	16
Configure the Port Mode	16
Breakout Panels	18
Getting Unpacked, Racked, Installed and Connected	18
Unpacking the GigaVUE TA Series Traffic Aggregator	18
Rack Mounting GigaVUE-TA200E	19
Attach the Brackets	19
Adjust Rear-Post Bracket Ears	20
Basic Connections and Configuration	20
Grounding the GigaVUE-TA200E	20
Connecting Power to GigaVUE-TA200E	21
Replacing Fans	22
Connecting Serial Console and Mgmt Ports	22
Configuring Basic Settings	23
Access the Command-Line Interface over the console Port	23

Port Licensing on GigaVUE-TA200E	27
Enabling Additional Ports	27
Advanced Features Licensing	28
Command-Line Basics	28
Command-Line Modes	28
Entering Commands in the CLI	29
Command-Line Syntax – Entering Commands	31
Config Mode Syntax	31
Paging through CLI Output	31
The Basic Commands	32
Completing the Initial Setup	34
Enter the Configure Command-Line Mode	35
SSH2	35
Advantages of SSH2	36
Changing Host Keys	36
Initial User Account Configuration	37
Configuring the GigaVUE TA Series Host Name	38
Configuring GigaVUE TA Series Node’s Time Options	38
Setting Time Manually	39
Performing One-Time NTP Server Synchronization	39
Using NTP Time Server for System Clock Synchronization	39
Enabling the Web Server	40
Configuring Automatic Email Notifications	41
Using a Custom Banner	43
Saving Changes	44
Connecting Ports on GigaVUE®TA Series	44
Transceiver—Rules and Notes	44
BiDi Optics Considerations	45
Transceiver Installation Instructions	45
MPO Cabling	45
MPO/MTP 12 Position Fiber Cable for Use with SR4 Transceivers	46
MTP/APC 12 Position Fiber Cable for Use with QSFP+ PLR4 Transceivers	46
MPO/MTP 24 Position Fiber Cable for Use with SR10 Transceivers	47
GigaVUE®TA Series Specifications	47
Physical Dimensions and Weight	47
Power Requirements	48
Environmental Specifications	48
Compliance	49
Warranty	49
Regulatory GigaVUE-TA200E	49
Additional Sources of Information	51
Documentation	51

How to Download Software and Release Notes from My Gigamon	53
Documentation Feedback	54
Contact Technical Support	55
Contact Sales	55
Premium Support	56
The VÜE Community	56
Glossary	57

GigaVUE TA Series Overview

GigaVUE TA Series nodes allow you to aggregate the traffic from multiple low-utilization links before sending the traffic to the GigaVUE HC Series nodes that form your Gigamon Deep Observability Pipeline.



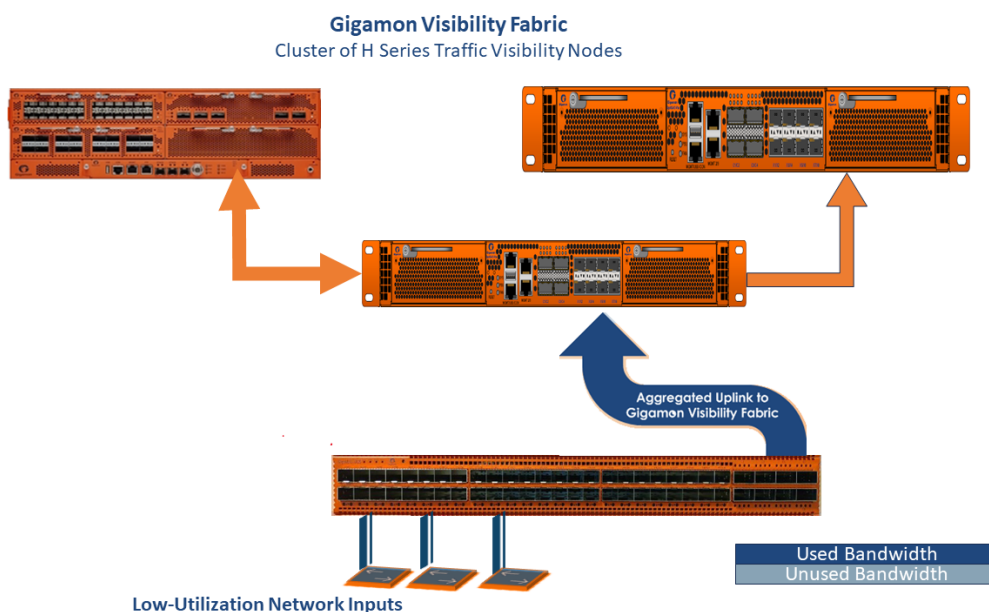

IMPORTANT: The GigaVUE TA Series support network, tool, clustering, and stack port connections to other GigaVUE TA Series nodes, including GigaVUE HC Series nodes.





Featured topics:

GigaVUE TA Series Nodes

GigaVUE TA Series includes the following models:

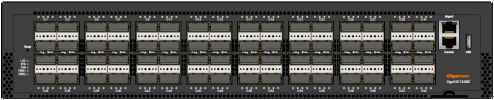
<p>GigaVUE-TA25</p>	<ul style="list-style-type: none"> ▪ 1 RU Footprint ▪ 48 1Gb/10Gb/25Gb ports and 8 40Gb/100Gb ports, dual hot-pluggable power supplies (AC/DC), four rear hot swappable fan modules, two console ports, and a 10M/100M/1Gb management port. ▪ Optional patch or breakout panel support ▪ Cluster with HC Series nodes 	
<p>GigaVUE-TA25E</p>	<ul style="list-style-type: none"> ▪ 1 RU Footprint ▪ 48 1Gb/10Gb/25Gb ports and 8 40Gb/100Gb port, dual hot-pluggable power supplies (AC/DC), four rear hot swappable fan modules, two console ports, and a 10M/100M/1Gb management port. ▪ Optional patch or breakout panel support ▪ Cluster with GigaVUE HC Series nodes 	
<p>GigaVUE-TA100</p>	<ul style="list-style-type: none"> ▪ 1RU Footprint ▪ 32 40Gb/100Gb ports, hot swappable fan modules ▪ Optional patch or breakout panel support ▪ Cluster with GigaVUE HC Series nodes 	
<p>GigaVUE-TA200</p>	<ul style="list-style-type: none"> ▪ 2RU Footprint ▪ 64 40Gb/100Gb ports, hot swappable fan modules ▪ Optional patch or breakout panel support ▪ Cluster with HC Series nodes 	

GigaVUE-TA200E	<ul style="list-style-type: none">▪ 2 RU Footprint▪ 64 QSFP28 ports (40G/100G), dual power supply modules (AC/DC) and hot swappable fan modules.▪ UART RS232 Console port (RJ45) and Management port (RJ45).	
GigaVUE-TA400	<ul style="list-style-type: none">▪ 1RU Footprint▪ 32 40Gb/100Gb/400Gb QSFP-DD/ QSFP28/QSFP+ ports, dual hot-pluggable power supplies (AC/DC), seven rear hot swappable fan modules, console port and a 10M/100M/1Gb management port.▪ Cluster with GigaVUE HC Series nodes	

GigaVUE TA Series Features and Benefits

GigaVUE TA Series nodes allow you to aggregate traffic from multiple network links from 1Gb up to 100Gb. The GigaVUE TA Series can pre-filter traffic for monitoring or be integrated into the GigaVUE HC Series cluster for end-to-end Flow Mapping® and management.

The GigaVUE HC Series and TA Series products share the same GigaVUE-OS software and are managed by GigaVUE-FM Fabric Manager for simplified operations. Traffic from any of these ports can be processed by GigaSMART traffic intelligence functions in GigaVUE HC Series devices to further optimize the traffic before it is sent to the tools.

GigaVUE TA Series nodes offer the following features and benefits:

- High-density visibility for 1Gb, 10Gb, 25Gb, 40Gb, 100Gb and 400Gb.
- Low profile 2RU for GigaVUE-TA200 and GigaVUE-TA200E design offers easy deployment at the top of rack or end of row in data centers.
- Depending on the model, the GigaVUE TA Series supports a wide variety of Gigamon® transceivers. Transceivers purchased from other vendors are not supported.
- Optional patch panel or breakout panel allows use of 40Gb ports as four individual 10Gb ports on all the GigaVUE TA Series nodes, or 100Gb ports as four individual 25Gb ports on GigaVUE-TA200, GigaVUE-TA200E, GigaVUE-TA25, GigaVUE-TA25E or 400Gb ports as four individual 100Gb ports on GigaVUE-TA400.

- All ports of same type and speed can be used to create GigaStream.
- Front to back cooling.
- Fan modules.
- AC or DC power supply. Included with each node is the redundant second power supply.

Standard GigaVUE HC Series Features

In addition to the features described above, the GigaVUE TA Series offers many standard features from the GigaVUE HC Series nodes:

Benefit	Descriptions
Remote Management	<p>Configure the GigaVUE TA Series Traffic Aggregator's operations from a command-line interface:</p> <ul style="list-style-type: none"> • Local access over the serial console port. • Remote network access using SSH2 over the 1000 Ethernet Mgmt port. • Secure access to the CLI, either through local authentication or optional RADIUS/TACACS+/LDAP support. • Powerful and flexible logging, including event notification via syslog, email, and SNMP traps.
Aggregate Links	<p>Send the data from multiple different network ports to a tool port or GigaStream, allowing you to combine traffic from multiple access points into a single stream for uplink to the Gigamon Deep Observability Pipeline.</p>
CLI Management	<p>The GigaVUE TA Series nodes feature a common CLI with other GigaVUE HC Series nodes.</p>
Command Abbreviation	<p>Type only as many letters of a command as are needed to positively differentiate from other available commands. For example, you only need to type con t to enter Config mode, not the full configure terminal command.</p>
SNMP Support	<p>Rely on secure SNMP v3 access to the onboard SNMP agent as well as v1/v2 SNMP traps.</p>
Email Notifications	<p>Use email alerts for proactive notification of a wide variety of GigaVUE TA Series node events, helping you keep tabs on system status in real time.</p>
Scalable Port Density	<p>The GigaVUE-TA100 can have either sixteen (16), twenty-four (24), or thirty-two (32) 100Gb ports enabled. Licenses are available for the additional two sets of 8 ports.</p> <p>The GigaVUE-TA200 can have either thirty-two (32) or sixty-four (64) 100Gb ports enabled. A license is available for the additional 32 ports.</p> <p>The GigaVUE-TA200E can have either thirty-two (32) or sixty-four (64) 40Gb/100Gb ports. A license is available for the additional 32 ports.</p> <p>The GigaVUE-TA25 has forty-eight (48) 1Gb/10Gb/25Gb ports and eight (8) 40Gb/100Gbports enabled.</p>

Benefit	Descriptions
	<p>A 24-port GigaVUE-TA25 called the GigaVUE-TA25A is also available. License is required to upgrade the GigaVUE-TA25A to include all (48) 1Gb/10Gb/25Gb ports as well as the eight (8) 40Gb/100Gb ports .</p> <p>The GigaVUE-TA25E has forty-eight (48) 1Gb/10Gb/25Gb ports and eight (8) 40Gb/100Gb ports enabled.</p> <p>The GigaVUE-TA400 has 32 40Gb/100Gb/400Gb QSFP-DD/QSFP28/QSFP+ ports and 7 rear hot swappable fan modules, console port and a 10M/100M/1Gb management port.</p> <p>The GigaVUE TA Series nodes make it easy to leverage the system's 10Gb or 40Gb port density, aggregating multiple underused 1Gb/10Gb/40Gb network ports to 10Gb/40Gb tool ports for uplink to the Gigamon Deep Observability Pipeline.</p>
Clustering	<p>The GigaVUE-TA100, GigaVUE-TA200, GigaVUE-TA200E nodes, GigaVUE-TA25 , GigaVUE-TA25E and GigaVUE-TA400 can cluster with other GigaVUE HC Series nodes.</p> <p>The GigaVUE-TA400 can cluster with all GigaVUE HC Series nodes and GigaVUE TA series nodes only with E-tag mode.</p> <p>This allows you to take advantage of the benefits of features such as GigaSMART.</p>
Ingress VLAN Tagging	<p>VLAN Tags can be added to the ingress packets on a per-port basis. This can help identify, differentiate or track incoming sources of traffic.</p>
GigaVUE-FM (Centralized Management System)	<p>Use the centralized GigaVUE TA Series Fabric Management System to review, configure, and update GigaVUE TA Series just like other GigaVUE HC Series.</p>

Introducing the GigaVUE-TA200E Chassis

This section describes the physical layout of the GigaVUE-TA200E chassis, including a description of all ports and connectors. The GigaVUE-TA200E chassis consists of a 2RU, rack-mountable, 19"-wide chassis with management, network, and tool ports at the front and power connections and fans at the rear. [Figure 1The GigaVUE-TA200E Chassis Front View](#) shows the ports at the front of the GigaVUE-TA200E chassis.

Refer to [Table 1: GigaVUE-TA200E Ports](#) for a description of each of the ports. [Figure 2The GigaVUE-TA200E Chassis Rear View](#) shows the fan modules and power supply units at the rear of the GigaVUE-TA200E chassis. Refer to [Chassis Cooling](#) for information on fans and temperature monitoring.

The GigaVUE-TA200E provides sixty-four ports, supporting high-density aggregation depending on the transceivers QSFP+ or QSFP28. The ports run at speeds of either 40Gb or 100Gb. With QSFP28 SR4 transceivers, a 100Gb port can be broken out into four 25Gb ports, called **4x25G** mode.

With 40Gb SR4, 40Gb ESR4 and PLR4QSFP+ transceivers(QSF-502,QSF-507,andQSF-506,respectively), a 40Gb port can be broken out into four 10Gb ports, called 4x10G mode

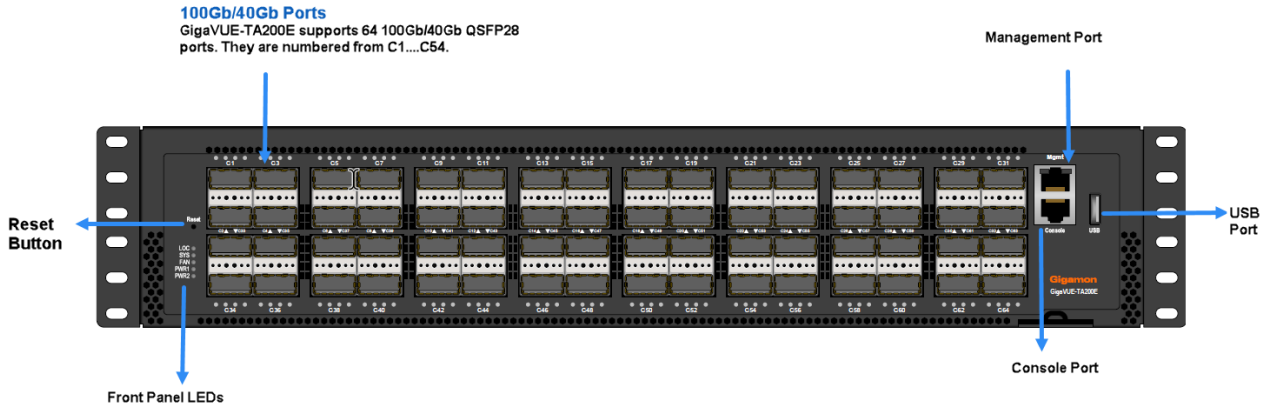

Figure 1 The GigaVUE-TA200E Chassis Front View

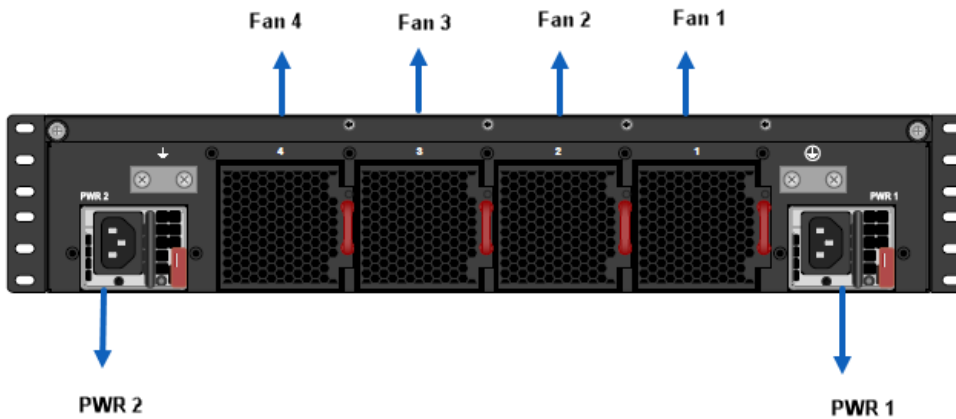

Figure 2 The GigaVUE-TA200E Chassis Rear View

GigaVUE-TA200E Ports and Description

Table 1: GigaVUE-TA200E Ports

Port	Description
Management	Use the Mgmt port for remote configuration of the GigaVUE-TA200E Traffic Aggregator over a 1000 Ethernet network.

Port	Description
Console	Use the console port for local configuration of the GigaVUE-TA200E Traffic Aggregator over a serial connection.
USB	The USB port is not supported in software version 6.0.98.
Ports c1.....c64 <ul style="list-style-type: none"> o c1x1.....c1x4 to c32x1.....c32x4 	<p>GigaVUE-TA200E includes 64 100Gb ports (c1..c64). These ports also support 40Gb speeds.</p> <p>The 40Gb/100Gb ports on the GigaVUE-TA200E can be broken out into four 10Gb/25Gb ports, called subports.</p> <p>The subports will all have the same speed(10Gb/25Gb). Subports will have x1 to x4 appended to their portID, for example, 1/1/c2x1.</p> <p>Once a 40Gb/100Gb port has been configured to operate as four 10Gb/25Gb ports, cable it to an optical patch panel or breakout panel, such as PNL-M341,which takes input from the GigaVUE-TA200E and splits it to four independent 10Gb/25Gb output ports.</p> <p>Port breakout is supported on the first 32 ports(ports c1..c32), When you use ports c1..c32 for port breakout, there is an impact on the ports in the lower row of the GigaVUE-TA200E.</p> <p>In the following list, ensure that the ports on the right do not have any configurations when you use the port on the left for port breakout:</p> <p>Example :-</p> <ul style="list-style-type: none"> • Fanout C1 → C33 Disabled • Fanout C3 → C35 Disabled • Fanout C21 → C53 Disabled • Fanout C31 → C63 Disabled • Fanout C2 → C34 Disabled • Fanout C4 → C36 Disabled • Fanout C24 → C54 Disabled • Fanout C32 → C64 Disabled <p>For example, if you use c1 for port breakout, ports c33 will be inactive. Ensure that the ports on the right side are disabled. You will receive an error message, if you try, for example ,to breakout port c1 when c33 is enabled.</p>
Pseudo-Slots	<p>GigaVUE-TA200E supports pseudo-slots . The mapping of pseudo-slots is as follows:</p> <p>Pseudo-slot 1 – 1/1/c9..c12, 1/1/c21..c24, 1/1/c41..c44, 1/1/c53..c56</p> <p>Pseudo-slot 2 – 1/1/c1..c8, 1/1/c33..c40</p> <p>Pseudo-slot 3 - 1/1/c13..c20, 1/1/c45..c52</p> <p>Pseudo-slot 4 -1/1/c25..c32, 1/1/c57..c64</p> <p>To view the CLI output of above use the command show pseudo-slot portmap box-id</p>
Transceivers	For details about the supported transceiver, cable type, and connectivity specifications, refer to “GigaVUE-OS Compatibility and Interoperability Matrix”.

Chassis Cooling

The fans on the GigaVUE TA Series-TA200E run at 100% of their maximum speed on power up, then drop to approximately 40% during normal operations. The temperatures of four components: transceivers, exhaust, CPU, and switch CPU, are monitored. When a component crosses a pre-defined threshold, the fan speed is adjusted dynamically, in increments of approximately 15%.

An SNMP trap is sent when a component reaches the threshold for warning, alert, or critical temperature conditions. Refer to [Table 2: Component Temperature Thresholds and Actions](#) for the temperatures at which the warning, alert, and critical traps are sent and any additional action that occurs at a threshold.

Table 2: Component Temperature Thresholds and Actions

CPU Temperature	Switch Board 2 Temperature	Switch Board 3 Temperature
95°C Warning trap sent	65°C Warning trap sent	40°C Warning trap sent
100°C Alert trap sent	70°C Alert trap sent; Switch CPU put in reset	45°C Alert trap sent; Transceiver power disabled
105°C Critical trap sent	75°C Critical trap sent	50°C Critical trap sent

The output of the following CLI command displays the current exhaust, CPU, and switch CPU temperatures, as well as the intake temperature:

```
gigamon-517859 # show environment
*** Box 1 (TA200E-Chassis) ***
-----
Fan tray 1 (TA200E-FANTRAY):
1st fan                : 7629 RPM
2nd fan                : 6103 RPM
-----
Fan tray 2 (TA200E-FANTRAY):
1st fan                : 7473 RPM
2nd fan                : 6103 RPM
-----
Fan tray 3 (TA200E-FANTRAY):
1st fan                : 7473 RPM
2nd fan                : 6103 RPM
-----
Fan tray 4 (TA200E-FANTRAY):
1st fan                : 7473 RPM
2nd fan                : 6103 RPM
-----
Card 1 (TA200E-LCC64):
CPU Card temperature   : 29 C
Switch Board 1 temperature : 35 C
Switch Board 2 temperature : 39 C
Switch Board 3 temperature : 28 C
```

```

Fan Board 1 temperature           : 30 C
Fan Board 2 temperature           : 30 C
CPU SOC temperature               : 48 C
    
```

The GigaVUE-FM screen would display the current exhaust, CPU, switch CPU temperatures, intake temperature as well as the fan speed in RPM as shown below:

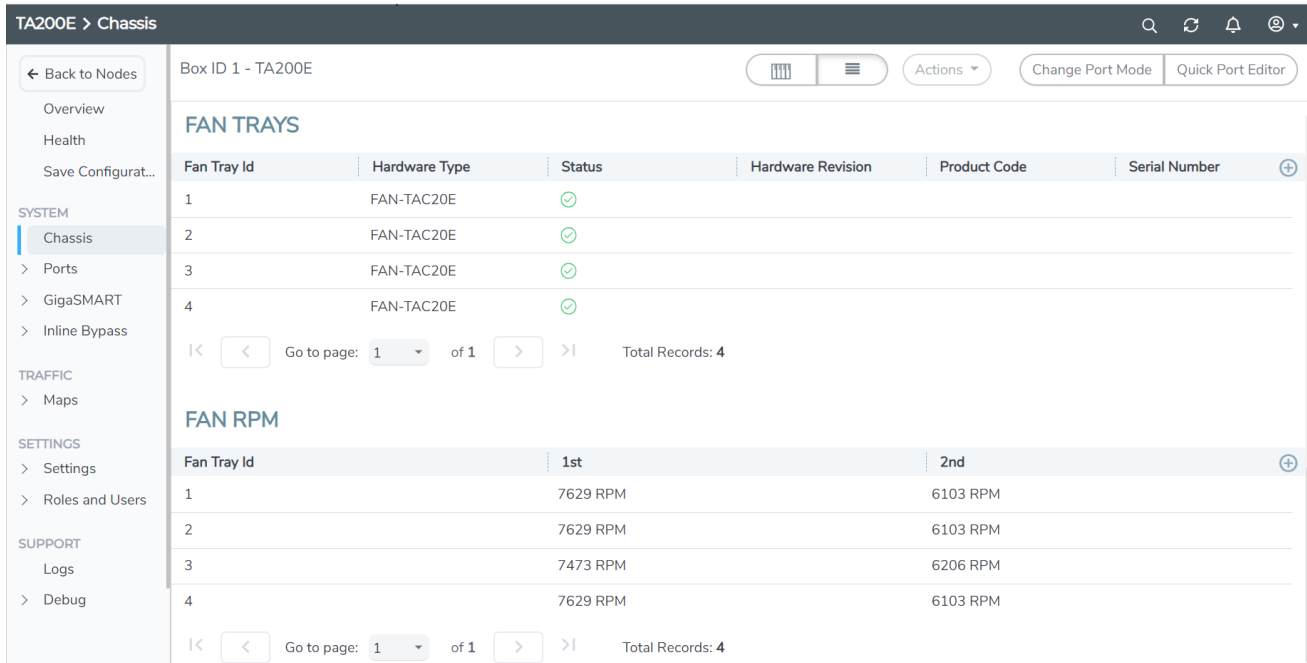

Power LEDs

The power LEDs on the front of the chassis (PWR1 and PWR2) are as follows:

- Solid GREEN indicates that the power supply unit (PSU) has power and is operating normally.
- Solid AMBER indicates that the PSU has failed.
- Off indicates that the PSU is present but without power.

System LED

The system LED on the front of the chassis (SYS) is as follows:

- Off indicates no power
- Solid GREEN indicates normal operation

Port Status LEDs

For each port, there are four (4) port status LEDs on the front of the chassis. At 40Gb and 100Gb speeds, only the first LED operates as follows:

- GREEN indicates the link is operationally UP with 100G/40G.

- Blinking GREEN indicates the port is operationally up and there is traffic flowing through the port.
- OFF indicates the port is administratively disabled/down

The other three LEDs operate as follows when the ports are in breakout mode :

- GREEN indicates the link is operationally UP.
- Blinking GREEN indicates the port is operationally up and there is traffic flowing through the port.
- OFF indicates the port is administratively disabled/down/non-breakout mode.

Global Fan LED

The global fan LED on the front of the chassis (FAN) is as follows:

- Solid GREEN indicates all fans are operating normally
- Solid AMBER indicates one or more fans have failed

GigaVUE-TA200E Rules and Notes

Keep in mind the following rules and notes when using the GigaVUE-TA200E:

GigaVUE-TA200E Rules and Notes	
Transceivers	For details about the supported transceiver, cable type, and connectivity specifications, refer to “GigaVUE-OS Compatibility and Interoperability Matrix” .
Network, Tool, Hybrid, Stack Port.	The 100Gb/40Gb ports on GigaVUE-TA200E can be used as network, tool, hybrid, stack-link ports.
Map Rules and Port Filters	The GigaVUE-TA200E supports 256 map rules per pseudo-slot , by default and 20 egress port filters per pseudo-slot. For details about the maximum map rules, refer to the <i>"Maximum Map Rules"</i> table in the <i>GigaVUE-FM Users Guide</i> .
Inline Bypass Feature	GigaVUE-TA200E does not support Inline Bypass feature.
PTP and Time Stamping Feature	GigaVUE-TA200E does not support PTP and Time stamping feature.
Port Licensing	On the GigaVUE-TA200E, only the first 32 out of 64 ports are enabled. A port license is available to enable an additional 32 ports.
Cluster Licensing	Connecting a GigaVUE-TA200E to a cluster requires the Advanced Features License.

AMI BIOS Images

The GigaVUE TA Series-TA200E has an AMI Basic Input/Output System (BIOS). The BIOS image is packaged with the software image, starting in software version 6.0.98. The BIOS contents are stored in flash memory, allowing the BIOS to be upgraded. There are two flash components, a primary and a secondary.

The following CLI command displays the two flash components and indicates the BIOS image from which the system booted using asterisks:

```
(config) show version
...
1st flash version: v40.01.01.01
2nd flash version: v40.01.01.01 **
SW BIOS version: N/A
...
```

If there is a component failure in the primary flash, the GigaVUE TA Series-TA200E boots from a backup golden BIOS image in the secondary flash. An SNMP trap can be configured to be sent when the system has booted from the secondary flash. The trap may indicate that the primary flash component needs to be serviced. The trap is as follows:

```
2ndflashboot: Secondary flash boot notification
```

Air Flow Direction

The air flow direction is from the front of the GigaVUE-TA200E chassis to the rear. The rear-mounted fans pull air from the front to the back of the chassis. Install the chassis so the intake air at the front of the chassis is cold.

AC and DC-Powered GigaVUE TA Series-TA200E Models

Gigamon provides both AC and DC-powered versions of the GigaVUE-TA200E. Refer to [Connecting Power to GigaVUE-TA200E](#).

Battery Caution

A disposable, non-rechargeable, Real Time Clock (RTC) Lithium manganese dioxide button battery is in the GigaVUE TA Series-TA200E. Note the following:

- There is a risk of fire if the battery is replaced with an incorrect type.
- Use only CR1220 type Lithium manganese dioxide button battery and replace with the same.

Breakout Modes

The breakout modes for GigaVUE TA Series can be in port mode. GigaVUE-TA25, GigaVUE-TA25E, GigaVUE-TA100, GigaVUE-TA200, GigaVUE-TA200E and GigaVUE-TA400 allows port breakout mode. Refer to [Configure the Port Mode](#) for further details.

Configure the Port Mode

The port breakout modes are as follows:

- **4x10Gb**—Specifies the **4x10Gb** port breakout mode. This mode applies to GigaVUE-TA100, GigaVUE-TA200, GigaVUE-TA200E, GigaVUE-TA25, GigaVUE-TA25E and GigaVUE-TA400. This mode provides a 4 x 10Gb breakout option for 40Gb ports.
- **4x25Gb**—Specifies the **4x25Gb** port breakout mode. This mode applies to GigaVUE-TA200, GigaVUE-TA200E, GigaVUE-TA25, GigaVUE-TA25E and GigaVUE-TA400 nodes. This mode provides a 4 x 25Gb breakout option for 100Gb ports.

- **4x100Gb**—Specifies 4x100Gb port breakout mode. This mode applies to GigaVUE-TA400 nodes. This mode provides a 4x100Gb breakout option for 400Gb ports
- **none**—Specifies no port breakout mode. This is the default mode for GigaVUE TA Series nodes.

Any of the 100Gb ports on the GigaVUE-TA100 (1/1/c1 to 1/1/c32), the first 32 ports on the GigaVUE-TA200 and GigaVUE-TA200E (1/1/c1 to 1/1/c32), the eight ports on GigaVUE-TA25 (1/1/c1..1/1/c8) or any ports in GigaVUE-TA400 can operate at 40Gb with QSFP+ SR transceivers.

A 40Gb port can be broken out into four 10Gb ports, called subports. In GigaVUE-TA25 only the ports c1 and c5 support 4 x10G breakout mode. The subports will all have the same speed (10Gb). Subports will have x1 to x4 appended to their port ID, for example, when port 1/1/c2 on GigaVUE-TA100 is configured to 4x10G mode, the subports will be: 1/1/c2x1, 1/1/c2x2, 1/1/c2x3, and 1/1/c2x4.

In **4x10Gb** mode, the subports can function as network, tool, stack, circuit and hybrid ports. GigaStream port members can be activated in the tool, stack, and hybrid port types. Subports on GigaVUE-TA100, GigaVUE-TA200, GigaVUE-TA200E and GigaVUE-TA400 can also function as stack ports.

- The maximum number of 10Gb subports on a GigaVUE-TA100 is 128 (32 x 4).
- The maximum number of 10Gb subports on a GigaVUE-TA200 and GigaVUE-TA200E is 128 (32 x 4).
- The maximum number of 10Gb subports on GigaVUE-TA25 is 8 (2 x 4)
- The maximum number of 10Gb subports on GigaVUE-TA25E is 32 (8x 4)
- The maximum number of 10Gb subports on a GigaVUE-TA400 is 128 (32 x 4)

The 100Gb QSFP28 ports (1/1/c1 to 1/1/c10 and 1/1/c23 to 1/1/c32) on the GigaVUE-TA200, GigaVUE-TA200E and GigaVUE-TA25 can be broken out into four 25Gb ports, called subports. In GigaVUE-TA25 only the ports c1 and c5 support **4 x25Gb** breakout mode. The subports will all have the same speed (25Gb). Subports will have x1 to x4 appended to their port ID, for example, when port 1/1/c2 on GigaVUE-TA200 is configured to 4x25G mode, the subports will be: 1/1/c2x1, 1/1/c2x2, 1/1/c2x3, and 1/1/c2x4.

- The maximum number of 25Gb subports on a GigaVUE-TA200 and GigaVUE-TA200E is 128 (32 x 4).
- In GigaVUE-TA25 the maximum number of 25Gb subports is 8 (2x 4)
- The maximum number of 10Gb subports on GigaVUE-TA25E is 32 (8x 4)
- The maximum number of 25Gb subports on a GigaVUE-TA400 is 128 (32 x 4).

In **4x25Gb** mode, the subports can function as network, tool, stack, circuit and hybrid ports. GigaStream port members can be activated in the tool, stack, and hybrid port types.

There are rules for configuring parent ports and subports. For more information, refer to the port command in the reference section of the GigaVUE-OS CLI Reference Guide. Once the port breakout mode has been configured, refer to [Breakout Panels](#).

For further information refer to GigaVUE-OS Compatibility and Interoperability Matrix.

Breakout Panels

Breakout panels let you connect ports on a GigaVUE TA Series node to a tool or network port or TAP for port breakout or aggregation.

The following breakout panels are available:

- PNL-M341/PNL-M341T
- PNL-M343/PNL-M343T

Refer to [G-TAP M Series Hardware Guide](#) for details.

Getting Unpacked, Racked, Installed and Connected

The following steps are required to get a GigaVUE TA Series Traffic Aggregator mounted and running:

Unpacking the GigaVUE TA Series Traffic Aggregator

1. Unpack the GigaVUE TA Series Traffic Aggregator and inspect the box it was shipped in. If the carton was damaged, please file a claim with the carrier who delivered it.
2. Remove the protective shipping covers and screws. Save the protective shipping covers and replace the screws in the holes on the system so that they are easily saved in case you need to ship the system again.
3. Next, select a suitable location for the rack unit that will hold the GigaVUE TA Series Traffic Aggregation node. Choose a location that is clean, dust free, and well ventilated. You will need access to a grounded power outlet. Avoid areas where heat, electrical wire, and electromagnetic fields are generated.

4. Plan for enough clearance in front of a rack so you can open the front door completely (approximately 25in) and enough clearance in the back of the rack to allow sufficient airflow.

Rack Mounting GigaVUE-TA200E

The GigaVUE-TA200E consists a Rack mounting kit which has 2 front-post brackets, 2 rear-post

brackets, 20 screws, and 2 ear-locking screws. To rack mount the chassis do the following:

Attach the Brackets

1. Attach each of the front- and rear-post brackets to the node using four of the included bracket screws.
2. Use an additional two screws to secure each of the rear-post brackets at the mid-point on the sides of the node.
3. Use the screws and cage nuts supplied with the rack to secure the node in the rack.

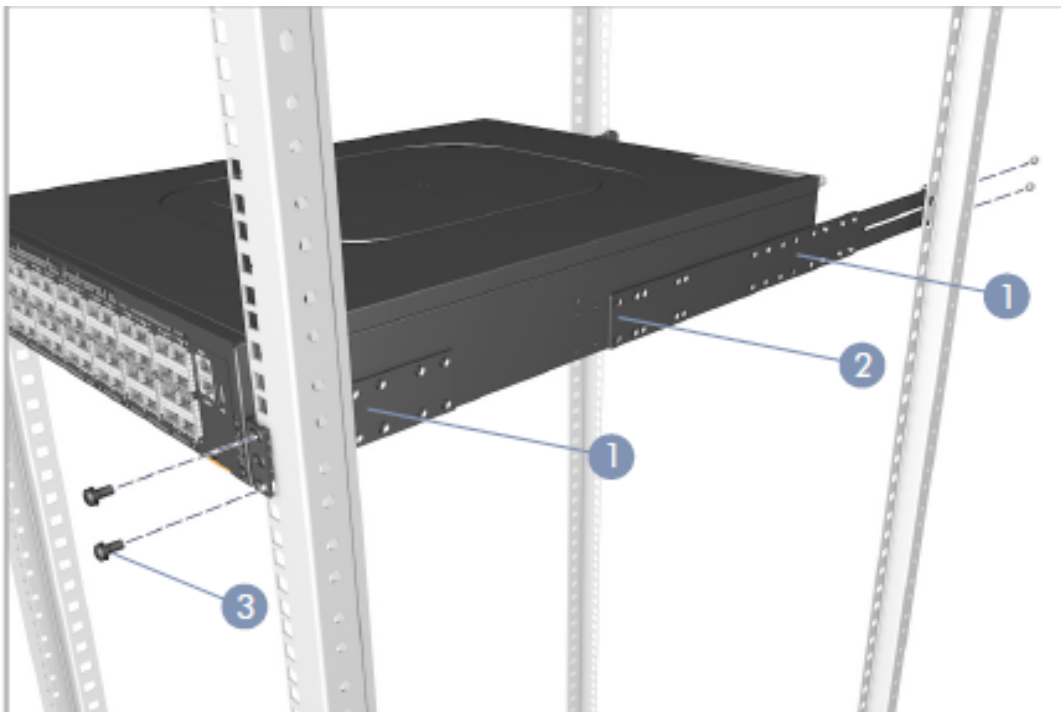

Caution: Installing the switch in a rack requires two people. One person should position the switch in the rack, while the other person secures it using the rack screws.

Adjust Rear-Post Bracket Ears

1. Lock the position of the rear-post bracket ears using the included position-locking screws. You can also adjust the rear-post bracket ears to fit different rack depths from 56 cm to 75 cm.

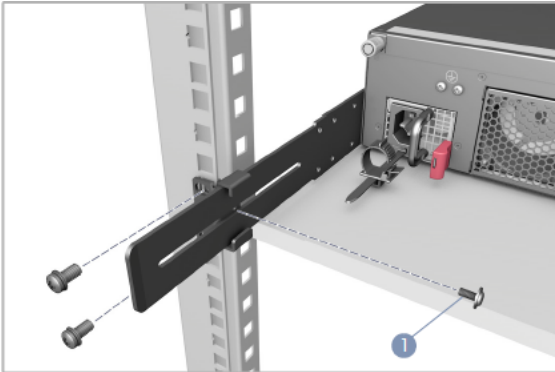

Basic Connections and Configuration

This chapter describes how to establish your first configuration session with the GigaVUE TA Series Traffic Aggregator and set the basic initial configuration options necessary to get you up and running.

Refer to the following sections for details:

Grounding the GigaVUE-TA200E

To ground the GigaVUE-TA200E do the following:

1. Ensure the rack is properly grounded and in compliance with ETSI ETS 300 253. Verify that there is a good electrical connection to the grounding point on the rack (no paint or isolating surface treatment).
2. Attach a #10 AWG grounding wire (not included) to the grounding point on the switch rear panel. Then connect the other end of the wire to rack ground.

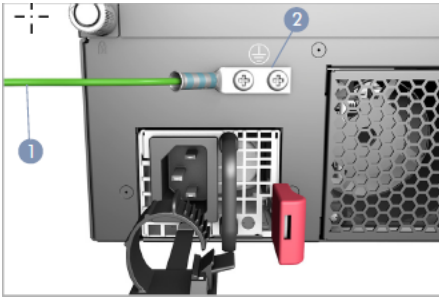

Caution: The earth connection must not be removed unless all supply connections have been disconnected.

Connecting Power to GigaVUE-TA200E

1. Install one or two AC or DC PWR modules in the switch. The switch supports up to two PWR modules that must have the same matching airflow direction as the installed fan trays.

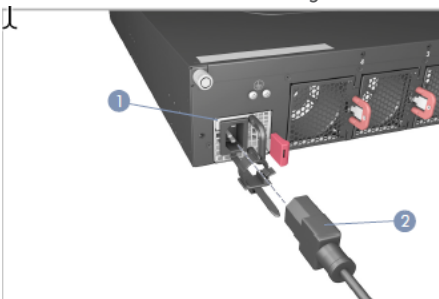

2. Connect an external AC or DC power source to the PWR modules.

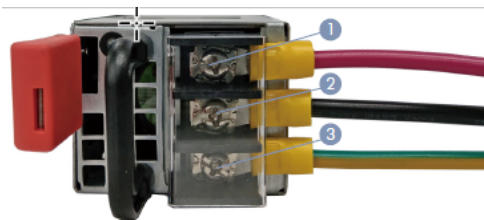

1. Connect the RTN return. (red wire).
2. Connect the -36 – -72 VDC (black wire).
3. Connect the Chassis Ground (yellow-green wire).

Caution: Use a UL/IEC/EN 60950-1 certified power supply to connect to a DC converter, and a #10 AWG (for - 36 VDC to -72 VDC PSU) wire to connect to a DC PSU.

Attention: Utilisez une alimentation certifiée UL/IEC/EN 60950-1 pour le connecter à un convertisseur CC et un câble AWG #10 (pour -36 VDC à -72 VDC) pour vous connecter à une alimentation CC.

Replacing Fans

Fans are field-replaceable. If a fan fails, you can replace it. Identify the fan that failed, and replace it with a working fan using the procedures in this section.

To remove a fan:

1. Locate lever and handle as shown below:

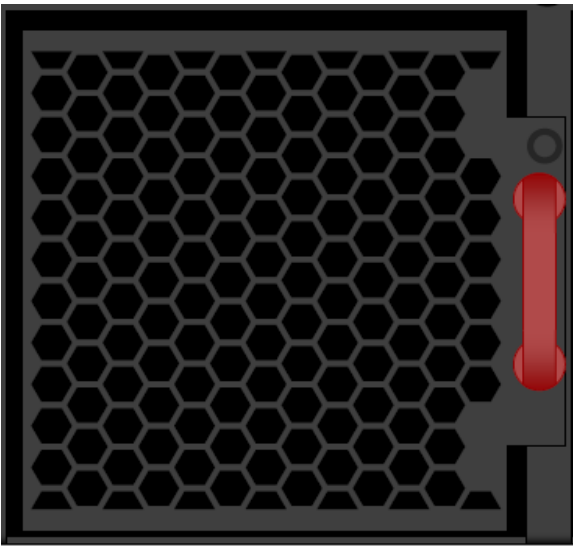

2. Push lever towards handle.
3. Pull on handle to remove the fan from the slot.

To insert a fan:

1. Place fan in empty slot.
2. Use handle to slide fan into slot.
3. When fan is fully inserted, it locks in place.

NOTE: The system will not power up without fan trays.

Connecting Serial Console and Mgmt Ports

To make basic connections (serial console and Mgmt ports):

1. Locate the DB9-to-RJ45 serial cable provided with the GigaVUE TA Series-TA400 node. This cable is called a *console cable*.

NOTE: This cable is Cisco-compatible. Refer to [Console Port Signaling and Cabling](#) for pinout details.

2. Connect the RJ45 end of the console cable to the **console** port.

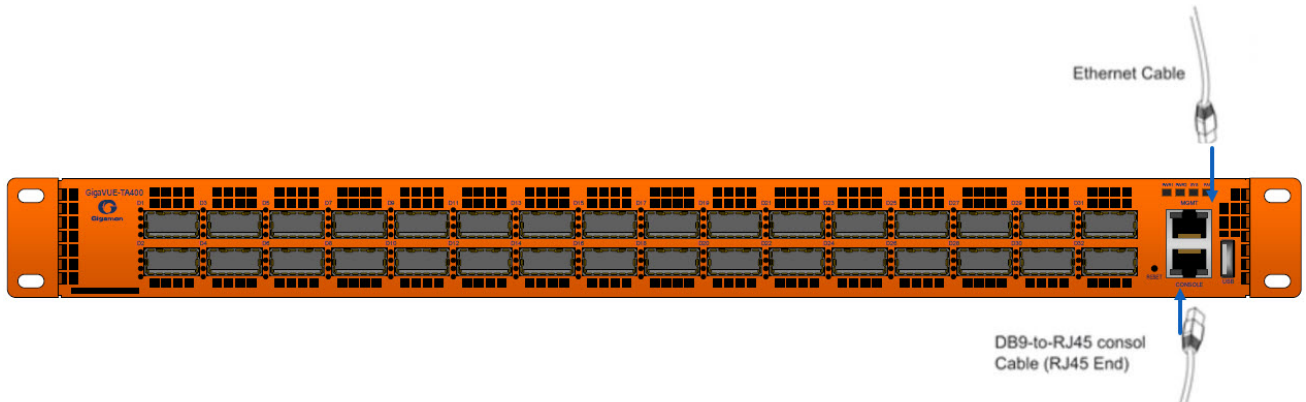

Figure 3 Connecting the Console and Management Ports

3. Connect the DB9 end of the console cable to a PC's COM port.
4. Connect a standard Ethernet cable (Cat5 or better) to the 10M/100M/1000M **Mgmt** port.
5. Connect the other end of the Ethernet cable to an Ethernet network.

Configuring Basic Settings

This section describes how to perform the initial configuration of basic settings over a serial terminal connection to the console port.

The system administrator must initially log in with a default **admin** account using a default password, and then must immediately change the password through the **jump-start** script. Refer to [Access the Command-Line Interface over the console Port](#).

Once you have used the console port to configure the Mgmt port's network properties, you can configure the GigaVUE TA Series node remotely using the Mgmt port's network connection.

NOTE: The same commands are available in the command-line interface regardless of how you connect.

Access the Command-Line Interface over the console Port

1. Make the basic power and console cable connections described in [Connecting Serial Console and Mgmt Ports](#) and power on the GigaVUE TA Series node.
2. Start a terminal application on the PC. Common terminal applications include TeraTerm, PuTTY, and Hyperterminal.

3. Select the COM port connected to the console cable attached to the console port. For example, **COM1**.
4. Configure the port settings for the console connection as follows:
 - o **Bits per second** – 115,200
 - o **Data bits** – 8
 - o **Parity** – None
 - o **Stop bits** – 1
 - o **Flow control** – None

NOTE: The GigaVUE-TA100, GigaVUE-TA200 and GigaVUE-TA25 support only a fixed serial baud rate of 115,200bps.

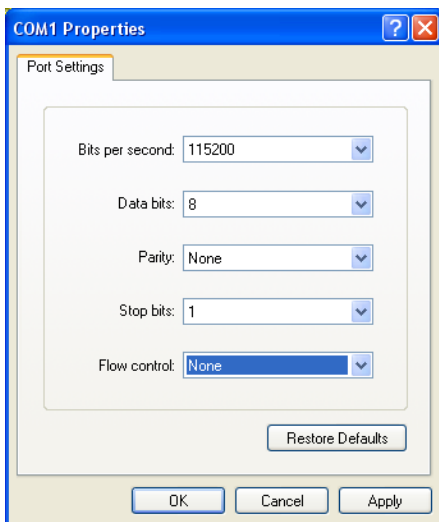

Figure 4 Setting COM Port Properties for the Console Connection

5. Start the terminal connection. You may need to press **Enter** a few times before you see the **login:** prompt.
6. Log in to the command-line interface with the following default user account and password:

User:admin

Password:admin123A!

The **configuration jump-start** automatically starts and forces a password change. The system administrator must change the password on the default **admin** account through the **jump-start** script. The default password (admin123A!) is no longer allowed. Refer to [Run the Jump-Start Script](#) for details.

A password must meet the following standards:

- include 8-30 characters
- include at least one numeral
- include at least one upper case letter
- include at least one lower case letter

- include at least one special character (for example, !, @, #, \$, %, ^, &, or * –, ASCII 0x21, 0x2F, 0x3A, 0x40, 0x5B, 0x5F, 0x7B, 0x7E)
- Must not include the user name or parts of full-name.

At the Admin password? prompt in the **jump-start** script, enter a new password that meets the standards, then confirm the password.

Run the Jump-Start Script

Gigamon provides the GigaVUE TA Series nodes with a **jump-start** script that walks you through the process of configuring basic settings. Run this script as follows:

1. Switch to **Config** mode.

There are three command entry modes, each with increasingly powerful rights – **Standard**, **Enable**, and **Config**. The jump-start script is only available in config mode:

- a. Type **en <Enter>** to switch to Enable mode.

The system prompt changes from **[hostname] >** to **[hostname] #**.

- b. Type **config t <Enter>** to switch to Config mode.

The system prompt changes from **[hostname] #** to **[hostname] (config) #**.

2. Reset the terminal settings to match the current window with the following command:

terminal resize

3. Type **config jump-start** to run the jump-start script.
4. Follow the jump-start script’s prompts to set each of the settings listed below.

NOTE: If you change your mind about a particular setting, you’ll have a chance to change it at the end of the script.

Hostname	The hostname appears in the system prompt and is used to identify the chassis in SNMP traps.
Management Port Network Settings	Use either DHCP or specify a static IP address and netmask. If you do not use DHCP, you are prompted to configure the following additional options: <ul style="list-style-type: none"> • Default Gateway Supply the IP address of the default gateway for the node. • DNS Server Supply the IP address of the DNS server for the node. Note that a valid DNS server is required for successful use of TACACS+. • Domain Name Supply the domain name for the node (for example, mycompany.com).
Default Gateway	Supply the IP address of the default gateway for the system.

DNS Server	Supply the IP address of the DNS server for the system. Note that a valid DNS server is required for successful use of TACACS+.
Domain Name	Supply the domain name for the system (for example, mycompany.com).
Enable IPv6?	You can enable the use of IPv6 for the management port. IPv6 is used in addition to IPv4 if you enable this option. If you enable the IPv6 you have the option of enabling IPv6 autoconfiguration or specifying a static address.
Security Settings	<p>Enable the following security settings:</p> <ul style="list-style-type: none"> ■ secure cryptography mode ■ secure passwords mode ■ minimum password length <p>Refer to the GigaVUE-OS CLI Reference Guide for information on security.</p>
Admin Password	The password for the admin account must be changed to a non-default password.
Cluster Enable?	<p>Enable cluster support if this node will be a part of a cluster of connected GigaVUE TA Series nodes. If you enable cluster support, the jump-start script prompts you to supply the Cluster ID, Cluster Name, and Cluster Mgmt Virtual IP Address. You can join an existing cluster by supplying values that match existing settings.</p> <p>If clustering is enabled, you will not be prompted for a box ID in the next step.</p> <p>Refer to the <i>GigaVUE-OS CLI Reference Guide</i> for information on setting up a cluster.</p> <div style="border: 1px solid black; padding: 5px; margin-top: 10px;"> <p>NOTE: Connecting a Traffic Aggregator to a cluster requires a license.</p> </div>
Box ID for the Node	<p>Supply a numerical box ID for the node. This box ID is used to identify network/tool ports in the node – the format is box ID/ slot ID/port ID.</p> <p>You will be prompted for a box ID only if clustering was not enabled in the previous step.</p>

5. Review your settings. You can change a setting by specifying its listed line number and re-entering the setting.
6. When you are satisfied with your settings, exit the script as prompted. The system automatically saves your settings.
7. Restart the system with the **reload** command.

Need to Change Any Settings?

If you need to change any of the settings you made in the jump-start script, you can either run the script again or change individual settings using the following commands in the Configure command mode:

- Use the **hostname** command to change the system's hostname.
- Use the **interface eth0** command to reconfigure or fine-tune Mgmt port settings, including basic IP settings (DHCP or static address and subnet mask) and physical parameters (duplex, MTU, and speed).
- Use the **ip** command to change the default gateway, DNS server, and domain name.
- You can also use the **username admin password <password>** command to change the **admin** user's password. Refer to [Changing the admin Account Password](#).

Refer to [Completing the Initial Setup](#) for a quick summary of the available GigaVUE TA Series commands for TA Series nodes.

Port Licensing on GigaVUE-TA200E

On the GigaVUE-TA200E, only the first 32 out of 64 100Gb ports are enabled. A port license is available to enable an additional 32 ports to expand from 32 ports to 64 ports.

Enabling Additional Ports

Contact your Sales Representative for information on obtaining a license key. Once you have obtained the license key for additional ports on GigaVUE-TA200E use the following command:

```
(config) # license install box-id <box ID> key <license key>
```

where:

- box ID is the box ID of the GigaVUE TA Series node
- license key is the license key obtained for the purposes of enabling additional ports

Use the following procedure to enable ports before starting to issue commands in the CLI:

1. Connect to the console port as described in the previous section.
2. Wait at least two minutes after the system prompt appears for the system to be initialized and then switch to **Configure** mode.

The GigaVUE TA Series node provides three command entry modes, each with increasingly powerful rights – **Standard**, **Enable**, and **Configure**. The jump-start script is only available in Configure mode:

- a. Type **en <Enter>** to switch to Enable mode.

The system prompt changes from **[hostname]>** to **[hostname] #**.

- b. Type **config t <Enter>** to switch to Config mode.

The system prompt changes from **[hostname] #** to **[hostname] (config) #**.

3. Reset the terminal settings to match the current window with the following command:

terminal resize

4. Use the **port** command with the **admin** argument to enable ports. For example, the following two commands enable all available ports on a fully licensed GigaVUE TA Series-TA200E:

(config) # port 1/1/q1..q4 params admin enable (config) # port 1/1/x24..x48 params admin enable

5. Save your changes so that ports come up automatically at the next reboot:

write memory

Advanced Features Licensing

GigaVUE-TA400 nodes can be clustered with GigaVUE TA Series and HC Series nodes. Clustering is enabled with an Advanced Features License. Contact your Sales representative for Advanced Features Licenses. Refer to [Contacting Sales](#).

Command-Line Basics

This section provides a quick orientation to the GigaVUE TA Series command-line interface – how to enter commands, how to get help, and so on.

Command-Line Modes

The GigaVUE-OS can operate in one of three modes, each with its own set of available commands – Standard, Enable, and Configure. When you first launch the CLI, you start in Standard mode with access to a limited amount of commands used to review system status. As you move from **Standard** mode to **Enable** mode to **Configure** mode, both the power and the number of commands available increase, as summarized in [Figure 5 GigaVUE-OS Command-Line Modes](#).

NOTE: If you are working simultaneously with multiple GigaVUE TA Series nodes, you may want to assign each a separate hostname so its easy to identify separate terminal sessions from the system prompt. Admin users can do this in Configure mode with the **hostname <name>** command.

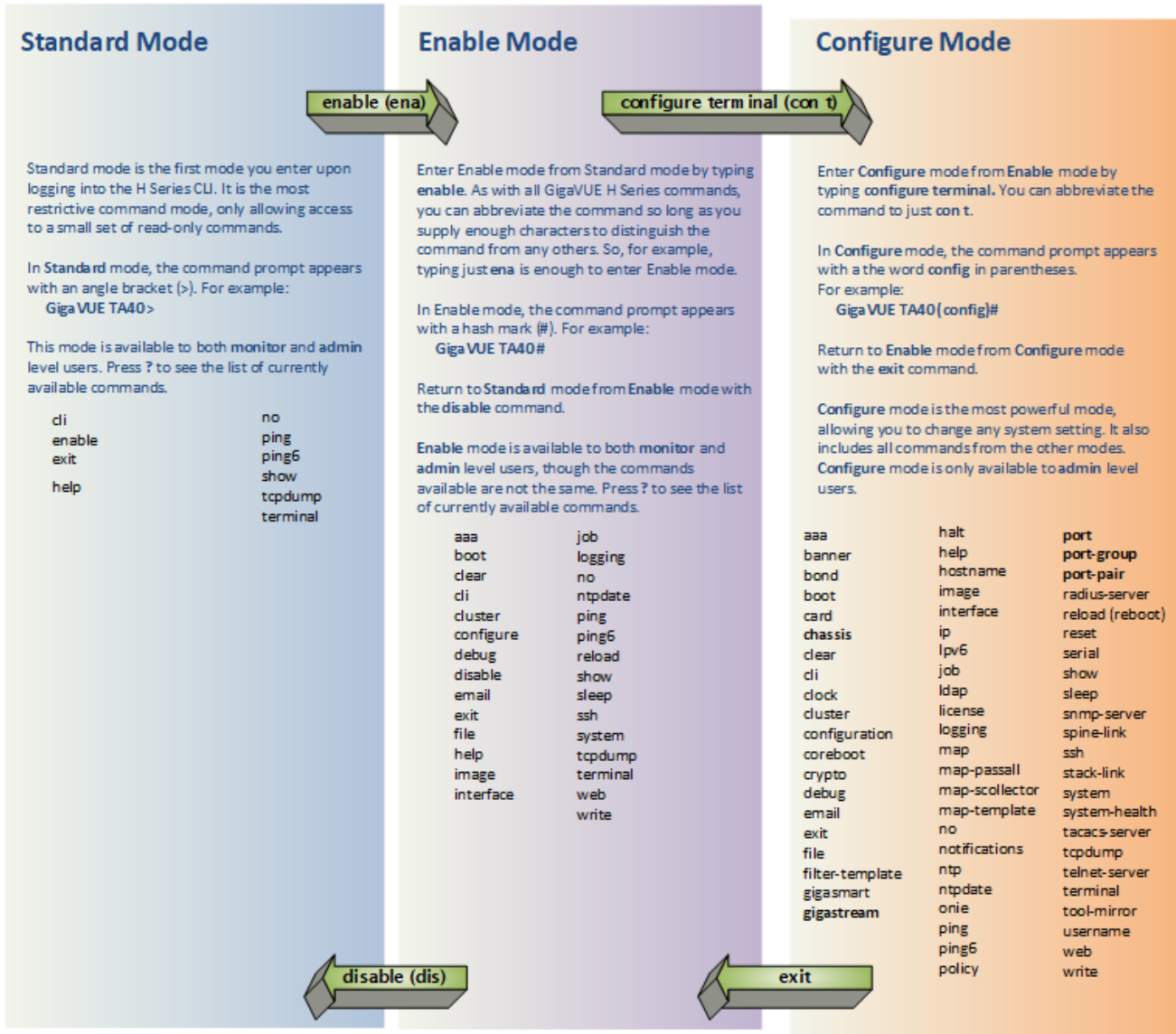

Figure 5 GigaVUE-OS Command-Line Modes

Entering Commands in the CLI

The GigaVUE TA Series CLI provides several conventions that make it easy to identify available commands and enter them quickly:

Technique	Description
Context-Sensitive Help	<p>The <code>?</code> symbol is the key to receiving help wherever you are in the CLI:</p> <ul style="list-style-type: none"> Type the <code>?</code> by itself to see a list of all available commands. Word Help – Type a partial word with a

Technique	Description
	<p>? mark immediately following the partially-typed word to see a list of all possible commands using the word entered so far.</p> <p>For example, if you typed i? in Configure mode, the CLI would return the following possible commands based on what you've entered so far:</p> <p>image interface ip</p> <ul style="list-style-type: none"> ▪ Command Help – Type a command followed by a question mark to see all possible arguments for the command as entered. If the system returns <cr>, that means the command can be entered as-is. <p>For example, if you entered gigastream ?, you would see alias. You can build your way through the entire command tree by entering ? after each new argument. For example, after entering gigastream alias myalias ?, you would see the next valid argument – port-list.</p> <p>NOTE: Typing ? accesses the help system immediately – you do not need to press <Enter>.</p>
<p>Partial Command Entry</p>	<p>For all GigaVUE TA Series commands and arguments, you only need to enter enough characters to distinguish the command from all other available commands. So, for example, you do not have to enter the full command username – there is only one command starting with the letter u, so you only have to enter u.</p>
<p>Command Completion</p>	<p>If you have partially typed a command, you can press Tab and the CLI will attempt to complete the command for you based on what's been entered so far.</p> <p>It is helpful to use the Command Completion feature together with partial command entry – you can press Tab while entering a command to see a list of all available commands matching what you've entered so far. For example, you can press p<Tab> and the system will return:</p> <p>pass-all ping port port-pair</p> <p>Based on this information, you know that you only need to enter the letter pa to uniquely identify what you've entered as pass-all.</p>

Command-Line Syntax – Entering Commands

You enter configuration commands for the GigaVUE TA Series node in the command-line interface by typing enough characters to uniquely identify the command and pressing **<Enter>**.

When entering commands, keep in mind the following rules:

- Successful commands return no response in the CLI; commands with errors return an error response beginning with **%**, followed by a short error description.
- All commands are case-sensitive and entered in lower case.
- Port numbers are entered in **<box ID>/<slot ID>/<port ID>** format. For the GigaVUE TA Series nodes, the chassis ID and slot number are always **1**.
- Strings must consist entirely of alphanumeric characters with no spaces. The only exceptions are the underscore (**_**), hyphen (**-**), exclamation point (**!**), “at” symbol (**@**), and period (**.**) characters. Those are allowed.

For example, in Config mode, **port 1/1/q12 alias My_Alias** is legal, but **port 1/1/q12 alias My Alias** is not.

NOTE: Some string fields do accept spaces provided the input is made inside quotation marks

Config Mode Syntax

When using the GigaVUE TA Series CLI, the “config” part of the command is implied whenever you are working in Configure mode. The system prompt helps you remember this by including the word **(config)** in parentheses. For example:

```
(config) #
```

So, instead of entering **config map** to connect a network port to a tool port, you just enter **map** followed by the necessary arguments. The **config** part is implied because you are already working in the Configure command mode. For example:

```
(config) # map alias myTA40map from 1/1/q1 to 1/1/q5
```

Paging through CLI Output

By default, the GigaVUE TA Series CLI returns output exceeding the configured terminal length in pages. The CLI provides the same features for working through the paged output as the Linux programs **less** and **more**. Press the **h** key to see paging options – [Figure 6 Viewing Paging Options](#) provides an example.

If you prefer, you can disable paging either for the current session or by default:

- **Disable for Current Session**
`(config) # no cli session paging enable`
- **Disable for All Sessions (Default)**
`(config) # no cli default paging enable`

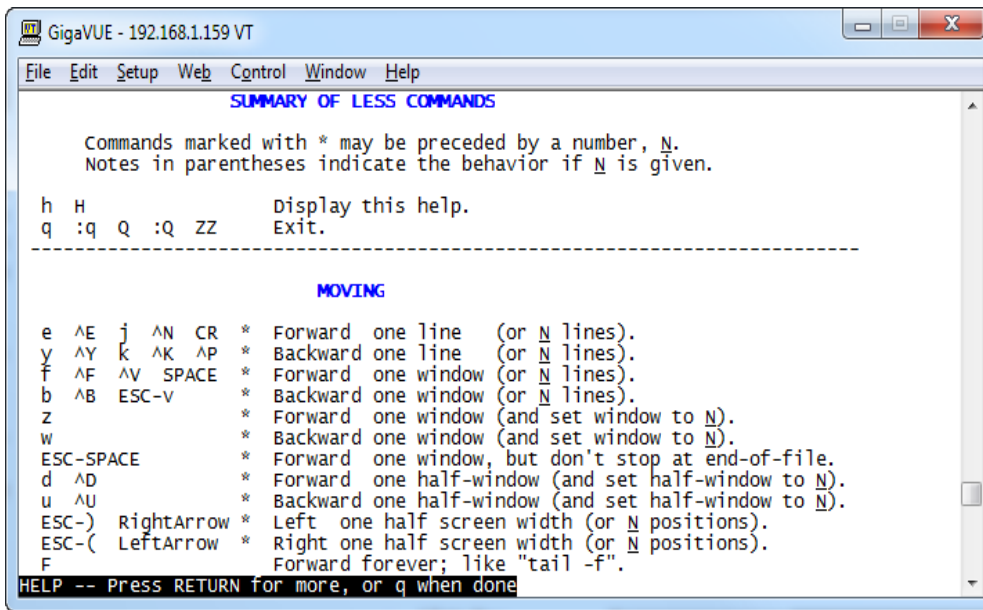

Figure 6 Viewing Paging Options

The Basic Commands

The following table lists each of the top level commands for the GigaVUE-OS CLI in Configure mode. Most commands have multiple supported arguments. You can see the exact arguments available at any point of command entry by typing it into the CLI followed by `?`.

Command	Description
aaa	Configure authentication, authorization, and accounting settings.
banner	Set a system login banner.
bond	Configure bonded interface settings.
boot	Configure system boot parameters.
card	Configure a card. On TA Series nodes, use the card command to enable additional ports on GigaVUE TA Series nodes.
chassis	Configure the chassis.
clear	Reset statistics or clear caches.
cli	Configure CLI shell options.
clock	Set the system clock or timezone.
cluster	Configure a cluster of connected nodes.
configuration	Manage configuration files.
configure	Enter Configure mode.
coreboot	Upgrades the BIOS image on GigaVUE-TA100, GigaVUE-HC1, GigaVUE-HC3 and GigaVUE-TA25.

Command	Description
crypto	Manage X.509 certificates for the node's Web server.
debug	Generate a dump file for use in debugging issues with Gigamon Technical Support.
disable	Leave Enable mode and return to Standard mode.
email	Configure email and event notification via email.
enable	Enter Enable mode.
exit	Leave Configure mode and return to Enable mode or log out of the CLI.
file	Manage TCP and debug dump files on disk.
filter-template	Configures flexible filter templates on GigaVUE-HC3, GigaVUE-TA100, and GigaVUE-TA25.
gigasmart	Configures a stack port interface to provide Internet connectivity for a GigaSMART card or module.
gigastream	Configure a GigaStream – a group of ports acting as a single addressable tool port destination or stack-link.
halt	Shut down the system without powering it off.
help	View a description of the interactive help system.
hostname	Specify the system's hostname. The hostname appears in the system prompt and in SNMP traps.
ib-pathway	Reserved for future use.
image	Manage system software images.
interface	Configure network interfaces.
ip	Configure IP settings for the eth0 Mgmt port.
ipv6	Configure IPv6 settings for the eth0 Mgmt port.
job	Configure scheduled jobs.
ldap	Configure LDAP server settings for authentication.
license	Activate features using license keys. GigaVUE-TA25 and GigaVUE-TA100, use this command to enable additional ports. (GigaVUE-TA25 has all ports enabled.) Use this command to enable clustering on the following TA Series nodes: GigaVUE-TA100 and GigaVUE-TA25.
logging	Configure event logging.
map	Configure maps and map rules to manage GigaVUE TA Series traffic distribution.
map-passall	Create a pass-all map to send all traffic on a network port to a tool port irrespective of the other packet distribution in place on the port.
map-collector	Configure shared collector map parameters.
map-template	Create a map template.
no	Delete or clear certain configuration options.
notifications	Configures notification settings.
ntp	Enable and disable the use of NTP, as well as add NTP servers.
ntpdate	Set system clock once from a remote server using NTP.
ping	Send ICMP echo requests to a specified host.
ping6	Send ICMPv6 echo requests to a specified host.
policy	Configures an active visibility policy.

Command	Description
<i>port</i>	Configure port type, parameters, and filters.
<i>port-group</i>	Create a group of ports.
<i>port-pair</i>	Configure a port-pair on a pair of network ports within the same node. A port-pair is a bidirectional connection in which traffic arriving on one port in the pair is transmitted out the other (and vice-versa) as a passthrough TAP.
<i>radius-server</i>	Configure RADIUS server settings for authentication.
<i>reload(reboot)</i>	Reboot or shut down the node.
<i>reset</i>	Reset specified portions of the system configuration to their factory states.
<i>serial</i>	Set options for the serial console port.
<i>sfp</i>	Reserved for future use.
<i>show</i>	Display configuration and status information for a wide variety of settings and entities.
<i>sleep</i>	Sleep for a specified number of seconds.
<i>snmp-server</i>	Configure SNMP settings, including the local SNMP server, notification events, and notification destinations.
<i>spine-link</i>	Configures spine links in a cluster with a leaf and spine architecture.
<i>ssh</i>	Enable and disable SSH access, as well as manage settings.
<i>stack-link</i>	Configure a stack-link between two nodes in a cluster. Stack-links are used to carry data traffic between nodes in a cluster.
<i>system</i>	Change system settings.
<i>system-health</i>	Configures system health behaviors.
<i>tacacs-server</i>	Configure TACACS+ server settings for authentication.
<i>tcpdump</i>	Display packets from any ethx port in the node on a network.
<i>terminal</i>	Set terminal parameters, including width and length.
<i>tool-mirror</i>	Configures a tool-mirror connection between two tool ports. A tool-mirror connection sends all packets arriving on one tool port to a second tool port on the same node.
<i>traceroute</i>	Trace the route packets take to a destination.
<i>tunnel</i>	Reserved for future use.
<i>uboot</i>	Installs new uboot software.
<i>username</i>	Manage user accounts.
<i>web</i>	Configure the Web server used for GigaVUE-FM GUI support on the node.
<i>write</i>	Save the running configuration to persistent storage.

Completing the Initial Setup

At this point, you have logged in to the command-line interface using the **admin** account, configured the **Mgmt** port's network properties for SSH access, and have explored the command-line interface.

There are a few more steps you should perform to complete the initial configuration before you set up network ports, tool ports, and aggregate traffic. These tasks include:

- Switch to the Configure mode. Refer to [Enter the Configure Command-Line Mode](#).

- Configure SSH access to the node. Refer to [SSH2](#).
- Configure some basic user accounts. Refer to [Initial User Account Configuration](#).
- Configure the node name. Refer to [Configuring the GigaVUE TA Series Host Name](#).
- Configure time and date options for the node. Refer to [Configuring GigaVUE TA Series Node's Time Options](#).
- Enable the Web server for Web-based GUI access. Refer to [Enabling the Web Server](#).
- Save your changes! Refer to [Saving Changes](#).

Enter the Configure Command-Line Mode

Keep in mind that the GigaVUE-OS have three different command modes for the CLI – **Standard**, **Enable**, and **Configure**. The commands described in the sections below are all only available in Configure mode. Switch to configure mode as follows:

Command	Notes
> enable	You only need to supply enough of each command to positively identify it among the other available commands. So, in this example, you could just type ena and press Enter.
# configure terminal	Similarly, this command can be entered as con t .
(config) #	Notice how the system prompt changes with each command mode. Command modes offer greater control over the box as you ascend from Standard to Enable to Configure .

SSH2

SSH2 is available for remote connections to the GigaVUE TA Series Traffic Aggregator's **Mgmt** port. By default, SSH2 is enabled. Use the **ssh** commands in Configure mode to enable or disable the corresponding connections. To disable the corresponding connection, you include **no** before the command, as demonstrated in the table below. For example:

Command	Notes
Enable: (config) # ssh server enable Disable: (config) # no ssh server enable	When SSH2 is enabled, you can use any compliant SSH2 client to connect to the command-line interface remotely. For example, to connect using the SSH2 client, PuTTY: <ol style="list-style-type: none"> Start PuTTY and enter the GigaVUE TA Series Traffic Aggregator's IP address in the Host Name field. Click the SSH protocol radio button. Click Open to open a connection. If this is your first connection PuTTY warns you that the host key presented by the GigaVUE TA Series node is not in your cache. You can add the key, connect without adding the key, or cancel the connection. Refer to Verifying Host Keys During Connection for information on how to verify that the host key shown is the correct one. Log in with GigaVUE TA Series credentials.

Advantages of SSH2

SSH2 is a secure choice for remote connections, providing an encrypted channel instead of relying on clear text. It also provides stronger user authentication capabilities, including the use of a public **host key**. Host keys uniquely identify a server, helping guarantee that the server you're connecting to is the server you think it is. The GigaVUE TA Series nodes also include default RSA v1/v2 and DSAv2-encrypted public host keys (SSH2 supports both RSA and DSA encryption algorithms). The first time you connect to the GigaVUE TA Series node with an SSH2 client, the client will warn you that the host keys are not in your local cache and show you the actual host key presented by the node. Your client will most likely give you the option of trusting the key, adding it to your local cache. Once you've trusted the key, your client will alert you during connection if a different key is presented.

IMPORTANT: Telnet server functionality is no longer supported as of GigaVUE-OS 5.7.00.

Verifying Host Keys During Connection

To verify that the host key presented during an SSH2 connection is in fact the GigaVUE TA Series node's, you can connect over the console port (refer to [Access the Command-Line Interface over the console Port](#)) and use the **show ssh server host-keys** command to see the current public host keys and fingerprints for the GigaVUE TA Series node. Paste these in a file and keep them nearby when you connect via SSH2 the first time. This way, you'll be able to compare the actual host key to what your SSH2 client says is being presented. Once you've verified that they are the same, you can choose to trust the host key, allowing future connections to take place seamlessly.

Changing Host Keys

You can use the **ssh server host-key generate** command to change the default host keys provided with the GigaVUE TA Series node. The command has the following syntax:

```
ssh server host-key <rsa1 | rsa2 |dsa2> <private-key | public-key> generate
```

For example, to configure a new RSAv1 public hostkey, you could use the following command:

```
(config) # ssh server host-key rsa1 public-key generate
```

Initial User Account Configuration

Before you start mapping traffic, you must change the password for the **admin** account and add a few other accounts for use by different level users. (You may have already used the jump-start script to change the password for the **admin** account.)

Changing the admin Account Password

1. To change the password for the **admin** account using the **username** command, refer to the following:

```
(config) # username admin password <password>
```

Passwords must meet the following standards:

- o Include 8-30 characters.
- o Include at least one numeral
- o Include at least one capital letter
- o Include at least one special character (for example, **!**, **@**, **#**, **\$**, **%**, **^**, **&**, or ***** – ASCII [0x21, 0x2F], [0x3A, 0x40], [0x5B, 0x5F], [0x7B,0x7E]).

Enter a new password that meets the standards and confirm the password.

Setting Up Some Basic Accounts

1. The TA Series node has a local account database that can optionally integrate with an LDAP, RADIUS, or TACACS+ server for authentication. Any account you want to authenticate using an external AAA server must have a matching account name in the local database.

Authentication, user levels, and roles are discussed in detail in the *GigaVUE-OS CLI Reference Guide*. For now, however, it is easiest to simply create a few basic user accounts with different privilege levels. In general, user privileges are as follows:

- o Admin users have access to all command modes, including Standard, Enable, and Configure. They also have full permissions for all network, tool, and stack ports.
- o Operator users have access to all command modes, including Standard, Enable, and Configure. However, they only have access to the network and tool ports associated with their user group. New users are created with the operator role by default. You can add additional roles with the **username <username> roles add <roles>** command.
- o Monitor users have access to the Standard and Enable command modes. They cannot configure packet distribution (or any other global GigaVUE TA Series node options), but they can use the show command to review many of the settings in place on the node.

The following username commands create a new admin user and a new operator user:

Command	Comments
<pre>(config) # username psandoval password Nine9.Eight8! (config) # username psandoval roles add admin</pre>	Creates a new account named psandoval with a password and grants it admin privileges.
<pre>(config) # username bcrawford password Seven7.Six6!</pre>	Creates a new account named bcrawford with a password. New users are automatically created with default operator level privileges, so there is no need to grant an additional role.

- Once you have configured these basic user accounts, use the **show usernames** command to review your settings. [Figure 7 Reviewing the User List](#) shows some sample **show usernames** output after several users have been added.

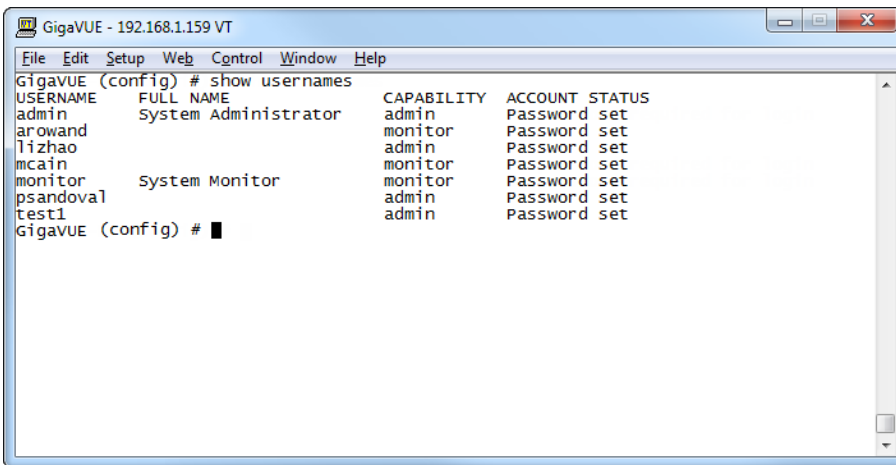

Figure 7 Reviewing the User List

Configuring the GigaVUE TA Series Host Name

It is generally a good idea to configure the GigaVUE TA Series node’s name, date, and time as part of your initial configuration. The following command shows how to set the system name. Refer to [Configuring GigaVUE TA Series Node’s Time Options](#) for information on setting options related to time and date.

Setting the System Name

- Use the **hostname** command to specify the system name. For example:

```
(config) # hostname GigaVUE TA Series-Customer
```

Configuring GigaVUE TA Series Node’s Time Options

The GigaVUE TA Series nodes include a variety of features for setting the time, including:

Method	CLI Command	For more information:
System Clock	<code>clock set hh:mm:ss yyyy/mm/dd</code>	Setting Time Manually
One-Time NTP Synchronization	<code>ntpdate <ntpserver address></code>	Performing One-Time NTP Server Synchronization
Persistent NTP Synchronization	Add server using <code>ntp server</code> command. Enable use of ntp with <code>ntp enable</code> command.	Using NTP Time Server for System Clock Synchronization

Setting Time Manually

The easiest way to set the GigaVUE TA Series node's time is manually with the **clock set** command. For example:

```
(config) # clock set 05:18:38 2011/05/24
```

NOTE: Even if you are using NTP/SNTP, it is a good idea to configure time manually as well. The GigaVUE TA Series node will automatically fall back to the manual time setting if it is unable to synchronize with the specified time server.

The **show ntp** will show the current state of the NTP server in use; the **show clock** command shows the current GigaVUE TA Series node's time.

Performing One-Time NTP Server Synchronization

You can perform a one-time synchronization with an NTP server using the **ntpdate** command. For example:

```
(config) # ntpdate time.nist.gov
```

Note that this method does not provide updates to correct clock drift over time. It is generally preferable to use persistent NTP synchronization with the **ntp** commands.

Using NTP Time Server for System Clock Synchronization

The GigaVUE TA Series nodes can optionally use one or more NTP servers for its time setting. Use the following procedure to add an NTP server to the GigaVUE TA Series node's list and enable the use of NTP.

1. Specify the address of the time server. For example, if the time server is on 192.168.1.10, you would use the following command:

```
(config) # ntp server 192.168.1.10
```

NOTE: There are many public NTP servers available on the Internet.

2. Turn on NTP with the following command:

```
(config) # ntp enable
```

3. The GigaVUE TA Series node connects to the specified NTP server and synchronizes to its time.

- 4. NTP reports times in UTC. Because of this, It is a good idea to specify the GigaVUE TA Series node’s timezone so that UTC can be converted to the local timezone.

You specify the timezone in terms of the offset from UTC (either plus or minus). For example, to set the timezone for a GigaVUE TA Series node in the United States for Pacific Standard Timezone, you would use the following command:

```
(config) # clock timezone America North United_States Pacific
```

Once you’ve finished configuring NTP options, use the **show ntp** command to check the status of clock synchronization (Figure 8 Checking NTP Status and Configuration).

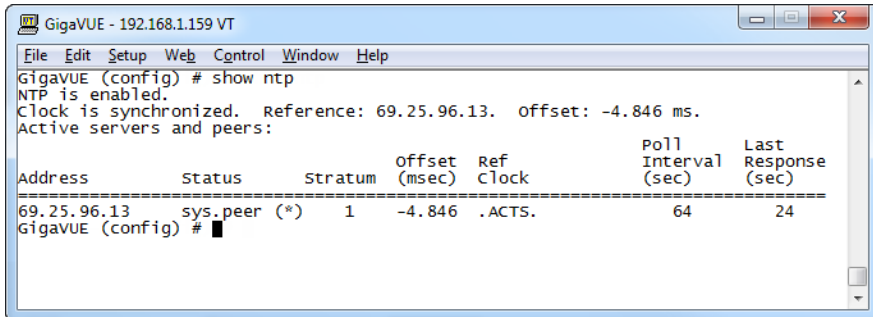

Figure 8 Checking NTP Status and Configuration

Enabling the Web Server

GigaVUE-FM is Gigamon’s Web-based management interface for the GigaVUE-OS, including the GigaVUE TA Series nodes. You can use GigaVUE-FM for many system configuration, management, and operations tasks.

To use GigaVUE-FM with a GigaVUE TA Series node, you must enable its Web server with the **web enable** command. For example:

```
(config) # web enable
```

Check the status of the Web server using the **show web** command. Make sure that **Web-based management console enabled:** is set to **yes**, indicating that the Web server is enabled. For example:

```
(config) # show web
Web-based management console enabled: yes

HTTP enabled:                yes
HTTP port:                   80
HTTP redirect to HTTPS:     yes
HTTPS enabled:               yes
HTTPS port:                  443
Require certificates from DoD CA: no
HTTPS certificate name:      default-cert
Listen enabled:              yes
No Listen Interfaces.

Inactivity timeout:          15 min
Session auto-logout:         2 hr 30 min
Session renewal:             30 min

Web client (for file transfers)
Proxy enabled: no
HTTPS server cert verify: yes
HTTPS supplemental CA list: default-ca-list
```

Configuring Internet Explorer for Use with GigaVUE-FM

GigaVUE-FM works best in Internet Explorer when the browser is configured to check for newer versions of stored pages every time pages are visited. Enable this option as follows:

1. Open Internet Explorer.
2. Select the **Tools > Internet Options** command.
3. In the **General** tab, locate the **Browsing history** section and click its **Settings** button.
4. Set the **Check for newer version of stored pages:** option to **Every time I visit the webpage.**
5. Click **OK** on the Temporary Internet Files and History Settings dialog.
6. Click **OK** on the Internet Options dialog.

Configuring Automatic Email Notifications

The GigaVUE TA Series nodes provide powerful email notification capabilities, automatically sending emails to specified addresses when any of a wide variety of events take place on the system. Gigamon strongly recommends that you configure this feature so you have immediate visibility of events affecting system health.

You configure automatic email notifications with the **email** command and its arguments. Start by making sure the CLI is in Configure mode. If the **(config)** entry appears in the system prompt, you are in Configure mode. If not, use the **enable** and **configure terminal** commands sequentially to change to Configure mode. Then, configure email notifications as follows:

Description	Command
<p>First, use the email mailhub command to specify the mail server to use for notification emails. In this example, the email server named smtp.emailsrvr.com is used. IP address can be used instead of a hostname.</p>	<pre>(config) # email mailhub smtp.emailsrvr.com</pre>
<p>Next, use the email auth command to supply the email account username and password. In this example, alerts@mycompany.com is shown with a password of mypassword123.</p>	<pre>(config) # email auth username alerts@mycompany.com (config) # email auth password mypassword123</pre>
<p>Once account is setup turn on email authentication.</p>	<pre>(config) # email auth enable</pre>
<p>Now that the settings are configured, let the system send emails. Set up who to send them to and when to send them. Use email notify recipient to configure the destinations for event notification emails. Multiple destinations can be specified by separating by commas with no spaces.</p>	<pre>(config) # email notify recipient cday@mycompany.com,mfelton@mycompany.com</pre>
<p>The email notify event command lets you configure which events will trigger automatic emails. There are quite a few events available – start by entering email notify event ? to see the list of available events. You can either enable individual</p>	<pre>(config) # email notify event all</pre>

Description	Command
<p>events, or, use the all argument to enable them all.</p>	
<p>It is a good idea to check your settings and make sure emails are sent successfully. You can do that with the email send-test command. If you do not receive the email, check the show log output to make sure the email was sent. Then, reconfigure email settings, if necessary.</p>	<p>(config) # email send-test</p>
<p>You may also want to configure and enable autosupport emails. Autosupport emails are sent directly to Gigamon’s Technical Support department when specified events take place, enabling proactive problem resolution. The GigaVUE TA Series is preconfigured with the correct destination address – you just need to enable the feature with the following command.</p> <p>Use show email events to see the list of events for which autosupport emails will be sent. You can change the list with the (no) email autosupport event command.</p>	<p>(config) email autosupport enable</p>
<p>That’s it! Emails will now be sent automatically to the configured addresses when any of the selected events take place.</p> <p>There are many other options for fine-tuning automatic email settings, including how to handle “dead letters” (emails that did not reach their recipient), how the email address of the GigaVUE TA Series should appear, the port for the email server, the reply-to address, and so on.</p>	

Using a Custom Banner

The GigaVUE TA Series nodes can display a customizable text banner at system startup before a user logs in. This way, users connecting to the system see the banner before they log in, giving them an idea of which system they are logging in to. The banner also

appears after a user logs out.

Use the **banner login** “<string>” command to configure the login banner. For example:

```
(config) # banner login "Pacific Call Center"
```

NOTE: You only need to use quotation marks for the <string> if it includes spaces.

The next time you log in or out of the GigaVUE TA Series node, you will see the customizable banner.

Saving Changes

It is a good idea to get into the habit of using the **write memory** command to save changes as you make them. Later on, when you start setting up packet distribution, your changes will be added to the active configuration right away but would not be saved across a system reboot unless you use the **write memory** command to save your changes to flash.

NOTE: The name of the factory-provided configuration file is **initial**. You can refer to the name of the most recently booted configuration file by using the **show running-configuration** command (or **show configuration**) and look for the **## Running database** entry.

Connecting Ports on GigaVUE[®] TA Series

This chapter provides information on the transceivers supported for use with the GigaVUE TA Series.

Refer to the following sections for details:

Transceiver—Rules and Notes

Keep in mind the following rules and notes when you connect and use GigaVUE TA Series nodes with transceivers:

- Always use transceivers purchased from Gigamon to ensure interoperability and performance. Gigamon does not support transceivers purchased from other vendors.
- After removing an optical transceiver, the best practice is to wait seventeen (17) or more seconds before re-inserting the same or different optical transceiver. This includes the intervals between removal/insertion/re-insertion.
- Use the **show port params all** command to see transceiver type information for each of the network/tool ports in the GigaVUE TA Series nodes. Check the value of the **SFP type** field for the ports in question.

- Following are the nomenclatures for the GigaVUE TA Series node port numbers:
 - Port numbers starting with a c (for example, c1) are 100Gb. They can also support 40Gb depending on the transceiver installed.
 - Port numbers starting with a q (for example, q1) are 40Gb.
 - Port numbers starting with an x (for example, x10) are 10Gb or 1Gb or 25Gb depending on the transceiver installed. They can also support 25 Gb on select platforms.

NOTE: The 40Gb QSFP+ SR Full Duplex (RX/TX) transceiver is not supported in conjunction with a TAP.

- For details about the supported transceivers, cable types, and connectivity specifications, refer to [“GigaVUE-OS Compatibility and Interoperability Matrix”](#).

BiDi Optics Considerations

There are several nuances to consider due to the complexity in 40Gb BiDi technology. Because of the nature of 40Gb BiDi technology, the same BiDi optic (Full Duplex or RX-only) cannot be used in all of the following situations. For example:

- On SPAN sessions, RX-only BiDi optics cannot be used. Full Duplex BiDi optics must be used.
- When receiving traffic from network links, RX-only BiDi optics must be used due to the way traffic is multiplexed over the fiber pair in 40Gb BiDi technology.
- When deploying over inline 40Gb BiDi links, Full Duplex BiDi optics must be used.
- When connecting two GigaVUE TA Series nodes through a cascade connection, Full Duplex BiDi optics must be used for the tool port. The network port may be either Full Duplex or RX-only BiDi optics.
- When stacking multiple GigaVUE TA Series nodes, 40Gb BiDi optics must not be used on stack links because the 40Gb BiDi technology is not compatible with the Gigamon stack protocol.

Transceiver Installation Instructions

Gigamon transceivers are keyed and can only be installed in one direction. Transceivers are hot-swappable – they can be installed or removed with the power on or off. Use the following procedures to install and remove SFPs from GigaVUE TA Series node.

IMPORTANT: Always use an ESD-preventive wrist or ankle strap and ensure that it makes good skin contact when installing or removing transceivers.

MPO Cabling

Refer to the following sections for MPO cabling:

- [MPO/MTP 12 Position Fiber Cable for Use with SR4 Transceivers](#)
- [MTP/APC Fiber Cable for Use with QSFP+ PLR4 Transceivers](#)

- MPO/MTP 24 Position Fiber Cable for Use with SR10 Transceivers
- For details about the supported transceiver, cable type, and connectivity specifications, refer to “GigaVUE-OS Compatibility and Interoperability Matrix”.
- For details about how to cable GigaVUE TA Series nodes, refer to “GigaVUE-OS Pluggables Guide”.

MPO/MTP 12 Position Fiber Cable for Use with SR4 Transceivers

This is a female to female Multi-fiber Push On (MPO) / Ultra Polished Connector (UPC) of cable type B. Figure 9 MPO/MTP 12 Position Fiber Cable provides cabling details for MPO/MTP 12 position fiber cable for use with 40Gb SR4 QSFP+, 40Gb ESR4 QSFP+, and 100Gb ER4 QSFP28 and 100Gb SR4 QSFP28 transceivers.

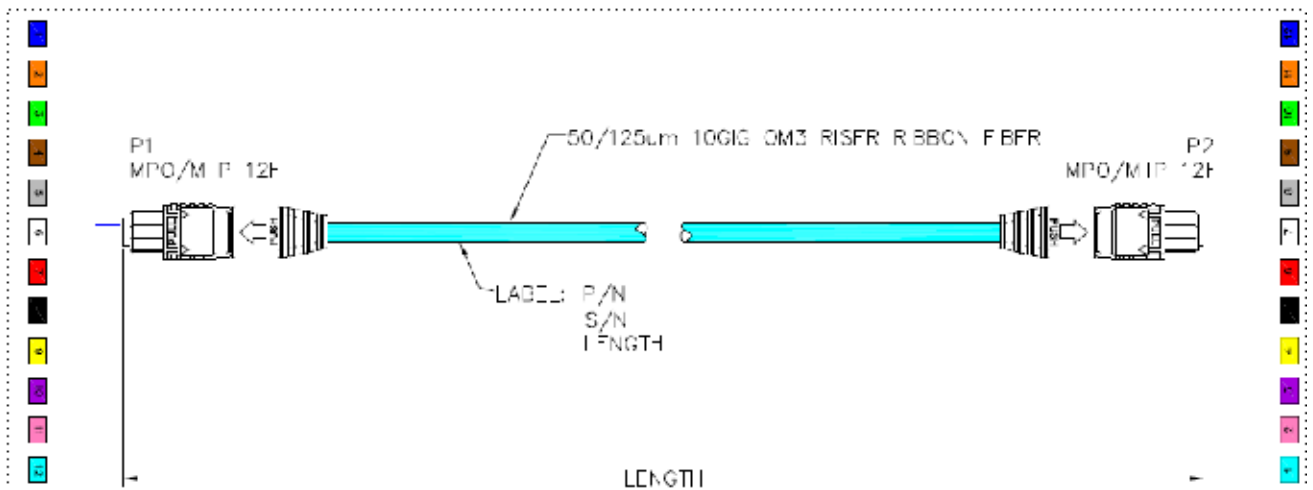

Figure 9 MPO/MTP 12 Position Fiber Cable

MTP/APC 12 Position Fiber Cable for Use with QSFP+ PLR4 Transceivers

The MTP cable is a high performance MPO connector. This is a female to female Angled Polished Connector (APC) of cable type B with an 8-degree angled end-face and a diameter of 9/125µm. Figure 10 MTP/APC Cable provides details for MTP/APC 12 position fiber cable for use with 40Gb QSFP+ PLR4 transceivers on the GigaVUE-TA100 node.

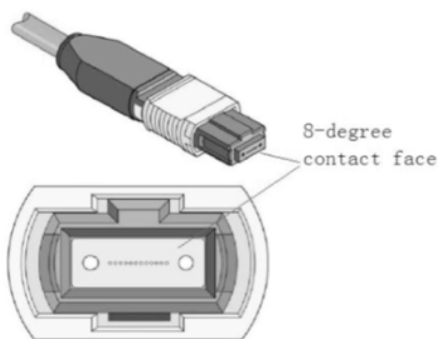

Figure 10 MTP/APC Cable

MPO/MTP 24 Position Fiber Cable for Use with SR10 Transceivers

This is a female to female Ultra Polished Connector (UPC) of cable type B. [Figure 11 MPO/MTP 24 Position Fiber Cable](#) provides cabling details for MPO/MTP 24 position fiber cable for use with 100Gb SR10 CXP transceivers.

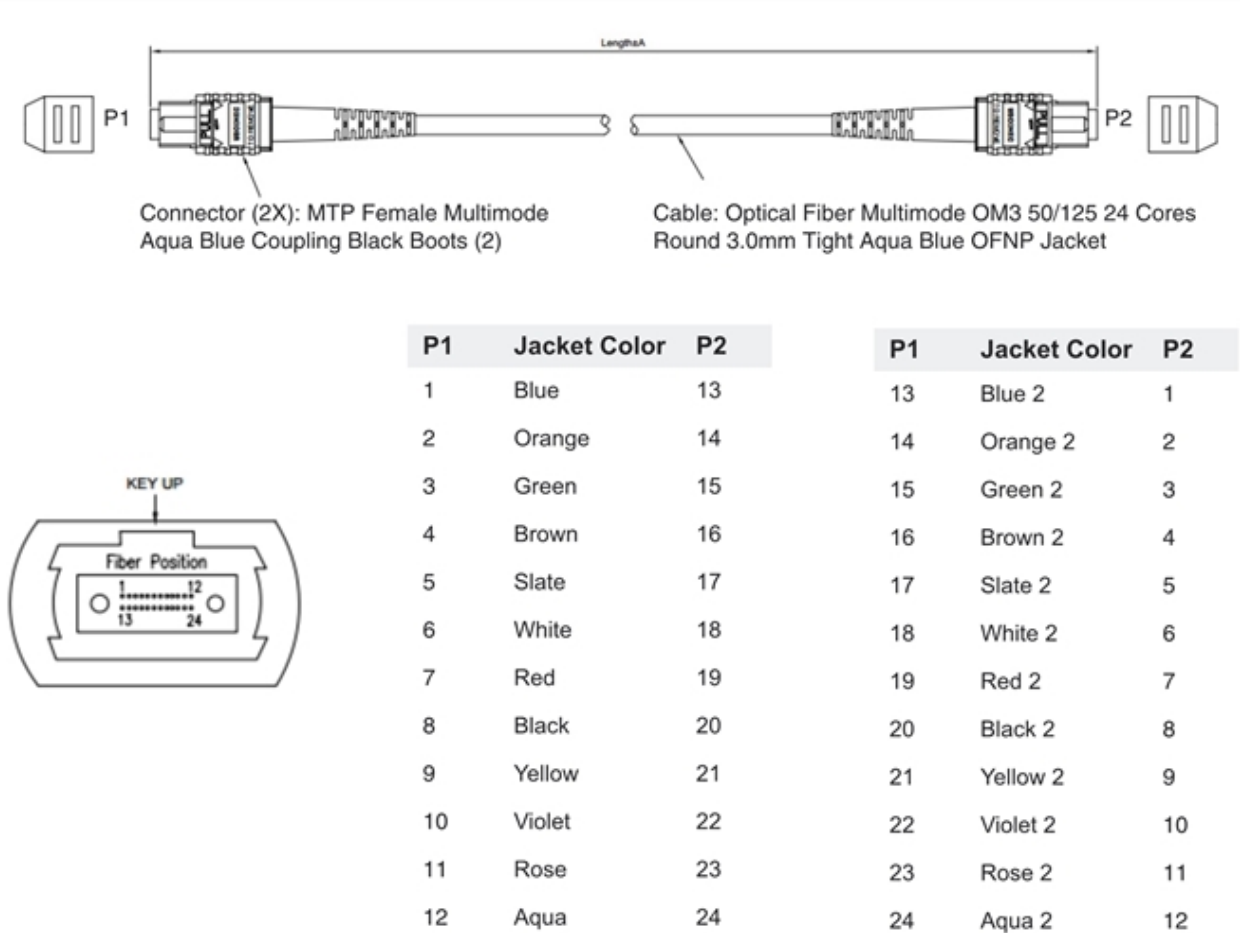

Figure 11 MPO/MTP 24 Position Fiber Cable

GigaVUE[®] TA Series Specifications

This section provides the physical specifications, power requirements and environmental specifications for the GigaVUE TA Series Traffic Aggregation node. Compliance for safety, emissions and immunity are also provided.

Physical Dimensions and Weight

The following table summarizes the dimensions for the GigaVUE TA Series Traffic Aggregation node GigaVUE-TA200E:

Product	Height	Width	Depth	Weight (AC Version)
GigaVUE-TA200E	3.45 in (2RU) (87.7 mm)	17.26 in (438.4 mm)	Metal to Metal 22.83in (580 mm)	31.1 lb (14.11kg)

Power Requirements

Each GigaVUE TA Series node come standard with dual, load sharing power supplies. [Table 3: Power Requirements for GigaVUE-TA200E](#) summarize the electrical characteristics for the GigaVUE-TA200E .

NOTE: Refer to [Connecting Power to GigaVUE-TA200E](#) for instructions on how to connect DC power supplies.

Table 3: Power Requirements for GigaVUE-TA200E

Power Configurations	1+1 Power: 2 Power Supply Modules
Max Power Consumption/Heat Output	800 Watts
AC Power Supply	Min/Max Voltage: 100V–240V AC, 50-60Hz Max PSM Input Current: 12-6A@100V
DC Power Supply	Min/Max Voltage: -36V to -72V DC Max PSM Input Current: 28-14A@-36V

Environmental Specifications

[Environmental Specifications Table 4: Environmental Specifications for GigaVUE-TA200E](#) summarizes the environmental specifications for the GigaVUE-TA200E.

Table 4: Environmental Specifications for GigaVUE-TA200E

Specification	Value
Operating Temperature	32°F to 113°F (0°C to 45°C)
Operating Relative Humidity	5% to 95%, non-condensing
Recommended Storage Temperature	-40°F to 158°F (-40°C to 70°C)
Recommended Storage Relative Humidity	15% to 85%, non-condensing
Altitude	Up to 13000ft (3.96km) for GigaVUE-TA200E

Compliance

This section provides compliance information for GigaVUE® TA Series Traffic Aggregation nodes.

Safety

UL (CSA 22.2 No 60950-1 & 62368-1; UL60950-1 & 62368-1)

CB (IEC/EN60950-1 & 62368-1)

NOM

CCC

Immunity

EN 55024:2010+A1:2015

IEC 61000-4-2/3/4/5/6/8/11

Emissions

EN 55032:2015+AC:2016, Class A

EN 61000-3-2:2014, Class A

EN 61000-3-3:2013

47 CFR FCC Part 15:2017, Subpart B, Class A

CE Mark

Warranty

Gigamon offers a range of premium support and extended services. For details regarding warranty, visit: <https://www.gigamon.com/support/warranty>.

Regulatory GigaVUE-TA200E

The Regulatory label for GigaVUE-TA200E is as shown below:

<p>Model/ 型號 / 型号: AS7816-64X</p> <p>產品名稱 / 产品名称: 100G 乙太網路交換器 / 以太网交换机</p> <p>Input Rating/ 輸入 / 输入: 100-240V~, 50-60Hz, 12-6A -36 - -72V ==, 28-14A</p> <p>This device complies with part 15 of the FCC Rules. Operation is subject to the following two conditions: (1) This device may not cause harmful interference, and (2) This device must accept any interference received, including interference that may cause undesired operation.</p> <p>CAN ICES-3(A) / NMB-3(A) CISPR Class A FCC Class A</p> <p>この装置は、クラスA機器です。この装置を住宅環境で使用すると電波妨害を引き起こすことがあります。この場合には使用者が適切な対策を講ずるよう要求されることがあります。</p> <p>此为A级产品, 在生活环境中, 该产品可能会造成无线电干扰。在这种情况下, 可能需要用户对干扰采取切实可行的措施。</p> <p>Edgecore Networks Corporation No.1, Creation 3rd Rd., Hsinchu Science Park, East Dist., Hsinchu City 30077, Taiwan, R.O.C</p> <p>制造商 / 製造商 智邦科技股份有限公司 製造地 / 製造地 台湾制造 / 台灣製造</p>	   <p>LISTED I.T.E. E141136</p>   <p>VCCI-A</p>     <p>12029-21-01261 R-R-ECn-AS7816-64X</p> <p>Made in Taiwan AZ 246000002426A R05</p>
--	---

Additional Sources of Information

This appendix provides additional sources of information. Refer to the following sections for details:

- [Documentation](#)
- [Documentation Feedback](#)
- [Contact Technical Support](#)
- [Contact Sales](#)
- [The VÜE Community](#)

Documentation

This table lists all the guides provided for GigaVUE TA Series software and hardware. The first row provides an All-Documents Zip file that contains all the guides in the set for the release.

NOTE: In the online documentation, view [What's New](#) to access quick links to topics for each of the new features in this Release; view [Documentation Downloads](#) to download all PDFs.

Table 1: Documentation Set for Gigamon Products

GigaVUE TA Series 6.6 Hardware and Software Guides
<p>DID YOU KNOW? If you keep all PDFs for a release in common folder, you can easily search across the doc set by opening one of the files in Acrobat and choosing Edit > Advanced Search from the menu. This opens an interface that allows you to select a directory and search across all PDFs in a folder.</p>
<p>Hardware</p> <p>how to unpack, assemble, rack-mount, connect, and initially configure ports the respective GigaVUE TA Series devices; reference information and specifications for the respective GigaVUE TA Series devices</p>
GigaVUE-HC1 Hardware Installation Guide
GigaVUE-HC3 Hardware Installation Guide
GigaVUE-HC1-Plus Hardware Installation Guide
GigaVUE-HCT Hardware Installation Guide
GigaVUE-TA25 Hardware Installation Guide
GigaVUE-TA25E Hardware Installation Guide
GigaVUE-TA100 Hardware Installation Guide
GigaVUE-TA200 Hardware Installation Guide

GigaVUE TA Series 6.6 Hardware and Software Guides

GigaVUE-TA200E Hardware Installation Guide

GigaVUE-TA400 Hardware Installation Guide

GigaVUE-OS Installation Guide for DELL S4112F-ON

G-TAP A Series 2 Installation Guide

GigaVUE M Series Hardware Installation Guide

GigaVUE-FM Hardware Appliances Guide

Software Installation and Upgrade Guides

GigaVUE-FM Installation, Migration, and Upgrade Guide

GigaVUE-OS Upgrade Guide

GigaVUE V Series Migration Guide

Fabric Management and Administration Guides

GigaVUE Administration Guide

covers both GigaVUE-OS and GigaVUE-FM

GigaVUE Fabric Management Guide

how to install, deploy, and operate GigaVUE-FM; how to configure GigaSMART operations; covers both GigaVUE-FM and GigaVUE-OS features

Cloud Guides

how to configure the GigaVUE Cloud Suite components and set up traffic monitoring sessions for the cloud platforms

GigaVUE V Series Applications Guide

GigaVUE V Series Quick Start Guide

GigaVUE Cloud Suite Deployment Guide - AWS

GigaVUE Cloud Suite Deployment Guide - Azure

GigaVUE Cloud Suite Deployment Guide - OpenStack

GigaVUE Cloud Suite Deployment Guide - Nutanix

GigaVUE Cloud Suite Deployment Guide - VMware (ESXi)

GigaVUE Cloud Suite Deployment Guide - VMware (NSX-T)

GigaVUE Cloud Suite Deployment Guide - Third Party Orchestration

Universal Cloud Tap - Container Deployment Guide

Gigamon Containerized Broker Deployment Guide

GigaVUE TA Series 6.6 Hardware and Software Guides

GigaVUE Cloud Suite for Nutanix Guide—GigaVUE-VM Guide

GigaVUE Cloud Suite Deployment Guide - AWS Secret Regions

GigaVUE Cloud Suite Deployment Guide - Azure Secret Regions

Reference Guides

GigaVUE-OS CLI Reference Guide

library of GigaVUE-OS CLI (Command Line Interface) commands used to configure and operate GigaVUE HC Series and GigaVUE TA Series devices

GigaVUE-OS Security Hardening Guide

GigaVUE Firewall and Security Guide

GigaVUE Licensing Guide

GigaVUE-OS Cabling Quick Reference Guide

guidelines for the different types of cables used to connect Gigamon devices

GigaVUE-OS Compatibility and Interoperability Matrix

compatibility information and interoperability requirements for Gigamon devices

GigaVUE-FM REST API Reference in GigaVUE-FM User's Guide

samples uses of the GigaVUE-FM Application Program Interfaces (APIs)

Release Notes

GigaVUE-OS, GigaVUE-FM, GigaVUE-VM, G-TAP A Series, and GigaVUE Cloud Suite Release Notes

new features, resolved issues, and known issues in this release ;
important notes regarding installing and upgrading to this release

NOTE: Release Notes are not included in the online documentation.

NOTE: Registered Customers can log in to [My Gigamon](#) to download the Software and Release Notes from the Software and Docs page on to [My Gigamon](#). Refer to [How to Download Software and Release Notes from My Gigamon](#).

In-Product Help

GigaVUE-FM Online Help

how to install, deploy, and operate GigaVUE-FM.

How to Download Software and Release Notes from My Gigamon

Registered Customers can download software and corresponding Release Notes documents from the **Software & Release Notes** page on to [My Gigamon](#). Use the My Gigamon Software & Docs page to download:

- Gigamon Software installation and upgrade images,
- Release Notes for Gigamon Software, or
- Older versions of PDFs (pre-v5.7).

To download release-specific software, release notes, or older PDFs:

1. Log in to [My Gigamon](#).
2. Click on the **Software & Release Notes** link.
3. Use the **Product** and **Release** filters to find documentation for the current release. For example, select Product: "GigaVUE-FM" and Release: "6.6," enter "pdf" in the search box, and then click **GO** to view all PDF documentation for GigaVUE-FM 6.6.xx.

NOTE: My Gigamon is available to registered customers only. Newer documentation PDFs, with the exception of release notes, are all available through the publicly available online documentation.

Documentation Feedback

We are continuously improving our documentation to make it more accessible while maintaining accuracy and ease of use. Your feedback helps us to improve. To provide feedback and report issues in our documentation, send an email to:

documentationfeedback@gigamon.com

Please provide the following information in the email to help us identify and resolve the issue. Copy and paste this form into your email, complete it as able, and send. We will respond as soon as possible.

Documentation Feedback Form		
About You	Your Name	
	Your Role	
	Your Company	
For Online Topics	Online doc link	<i>(URL for where the issue is)</i>
	Topic Heading	<i>(if it's a long topic, please provide the heading of the section where the issue is)</i>

For PDF Topics	Document Title	<i>(shown on the cover page or in page header)</i>
	Product Version	<i>(shown on the cover page)</i>
	Document Version	<i>(shown on the cover page)</i>
	Chapter Heading	<i>(shown in footer)</i>
	PDF page #	<i>(shown in footer)</i>
How can we improve?	Describe the issue	<i>Describe the error or issue in the documentation. (If it helps, attach an image to show the issue.)</i>
	How can we improve the content? Be as specific as possible.	
	Any other comments?	

Contact Technical Support

For information about Technical Support: Go to **Settings**  > **Support** > **Contact Support** in GigaVUE-FM.

You can also refer to <https://www.gigamon.com/support-and-services/contact-support> for Technical Support hours and contact information.

Email Technical Support at support@gigamon.com.

Contact Sales

Use the following information to contact Gigamon channel partner or Gigamon sales representatives:

Telephone: +1.408.831.4025

Sales: inside.sales@gigamon.com

Partners: www.gigamon.com/partners.html

Premium Support

Email Gigamon at inside.sales@gigamon.com for information on purchasing 24x7 Premium Support. Premium Support entitles you to round-the-clock phone support with a dedicated Support Engineer every day of the week.

The VÜE Community

The **VÜE Community** is a technical site where Gigamon users, partners, security and network professionals and Gigamon employees come together to share knowledge and expertise, ask questions, build their network and learn about best practices for Gigamon products.

Visit the VÜE Community site to:

- Find knowledge base articles and documentation
- Ask and answer questions and learn best practices from other members.
- Join special-interest groups to have focused collaboration around a technology, use-case, vertical market or beta release
- Take online learning lessons and tutorials to broaden your knowledge of Gigamon products.
- Open support tickets (Customers only)
- Download the latest product updates and documentation (Customers only)

The VÜE Community is a great way to get answers fast, learn from experts and collaborate directly with other members around your areas of interest.

Register today at community.gigamon.com

Questions? Contact our Community team at community@gigamon.com.

Glossary

D

decrypt list

need to decrypt (formerly blacklist)

decryptlist

need to decrypt - CLI Command (formerly blacklist)

drop list

selective forwarding - drop (formerly blacklist)

F

forward list

selective forwarding - forward (formerly whitelist)

L

leader

leader in clustering node relationship (formerly master)

M

member node

follower in clustering node relationship (formerly slave or non-master)

N

no-decrypt list

no need to decrypt (formerly whitelist)

nodecryptlist

no need to decrypt- CLI Command (formerly whitelist)

P

primary source

root timing; transmits sync info to clocks in its network segment (formerly grandmaster)

R

receiver

follower in a bidirectional clock relationship (formerly slave)

S

source

leader in a bidirectional clock relationship (formerly master)